



User Guide

PC6-TANGO • CompactPCI® PlusIO CPU Card
Intel® Atom™ E3900 Series Processor (Apollo Lake-I SoC)

Document No. 8565 • Edition 6 • 19 March 2018

Preliminary



Contents

About this Manual	5
Edition History	5
Related Documents	6
Nomenclature	7
Trade Marks	7
Legal Disclaimer - Liability Exclusion	7
Standards	8
Overview	9
Technical Features	11
Feature Summary	11
Power Requirements	16
Block Diagram	17
Top View Component Assembly	18
Bottom View Component Assembly	19
Front Panel Connectors	20
Front Panel Switches & Indicators	20
On-Board Connectors & Sockets	21
Pin Headers	21
Jumpers	21
Microprocessor	22
Thermal Considerations	23
Main Memory	24
Graphics Subsystem	25
LAN Subsystem	26
Serial ATA Interface (SATA)	27
PCI Express® Interface	28
Universal Serial Bus (USB)	29
Utility Interfaces	30
Real-Time Clock	31
SPI Flash	32
CFast™	33
e•MMC	33
Micro SD Card	33
Reset	34
Watchdog	36
Front Panel LEDs	37
PG (Power Good) LED	37
GP (General Purpose) LED	38
HD (Hard Disk Activity) LED	38
EB (Ethernet Backplane) LED	39

Hot Swap Detection	40
Power Supply Status (PWR_FAIL#)	40
Mezzanine Side Board Options	41
CompactPCI® PlusIO	44
Installing and Replacing Components	47
Before You Begin	47
Installing the Board	48
Removing the Board	49
EMC Recommendations	50
Replacement of the Battery	51
Technical Reference	52
Local PCI Devices	52
Local SMB/I ² C Devices	53
Board Control and Status Registers (BCSR)	54
Write/Read Control Register 0	55
Read/Clear Status Register 0	56
Read/Clear Status Register 1	57
Read PLD Revision Register	58
GPIO Usage	59
GPIO Usage APL-I SoC	59
J-GP UEFI/BIOS Defaults & IEEE 1588 Pulse per Second	61
Manufacturer Mode Jumper (J-MFG)	62
RTC Reset (J-RTC)	63
Connectors	64
Front Panel Connectors	65
DisplayPort Connectors	66
USB Connectors	67
Ethernet Connectors RJ45	68
Option M12 X-Coded Ethernet Receptacles	69
microSD Card Holder	71
CFast™ Card Holder	72
Mezzanine Connectors	75
Expansion Interface P-EXP	76
High Speed Expansion Connector P-HSE	77
Pin Headers & Debug	79
Front Panel Handle Microswitch Header P-FPH	79
PLD Programming Header P-PLD	80
Firmware Programming Header P-SPI	81
Processor Debug Header P-MIPI	82
Power Terminal Block	83
Backplane Connectors	84

CompactPCI J1	85
CompactPCI J2 (PlusIO)	87
Mechanical Drawing	90

About this Manual

This manual describes the technical aspects of the PC6-TANGO, required for installation and system integration. It is intended for the experienced user only.

Edition History

Ed.	Contents/Changes	Author	Date
1	User Manual PC6-TANGO, english, preliminary edition (draft) Text #8565, File: pc6_ug.wpd	jj	18 August 2017
2	Edited "Local PCI Devices" table, "GPIO Usage" table, BCSR registers, some clean up	gn	2017-09-27
3	Added option M12-X coded front panel GbE connectors	jj	20 October 2017
4	Added photos, warning regarding usage in a 64-bit classic environment also added to table 'Backplane Connector J2' (was already enclosed in section 'CompactPCI® PlusIO')	jj	8 December 2017
5	Removed PR1-RIO (obsolete)	jj	8 March 2018
6	Added MTBF	gn	2018-03-19

Related Documents

Related Information	
PC6-TANGO Home	www.ekf.com/p/pc6/pc6.html
PC6-TANGO User Guide	www.ekf.com/p/pc6/pc6_ug.pdf

Related Documents CompactPCI® Serial & CompactPCI® PlusIO	
CompactPCI® Serial & PlusIO Overview	www.ekf.com/s/smart_solution.pdf
CompactPCI® PlusIO Home	www.ekf.com/p/plus.html
CompactPCI® Serial Home	www.ekf.com/s/serial.html

Related Documents Mezzanine Modules and Side Cards	
C40 ... C48 Series Mezzanine Storage Modules	www.ekf.com/c/ccpu/c4x_mezz_ovw.pdf
C48-M2 Dual M.2 SATA SSD Mezzanine Storage Module	www.ekf.com/c/ccpu/c48/c48.html
PCL-CAPELLA Mezzanine Side Card	www.ekf.com/p/pcl/pcl.html
PCS-BALLET Mezzanine Side Card	www.ekf.com/p/pcs/pcs.html
SCS-TRUMPET Mezzanine Side Card	www.ekf.com/s/scs/scs.html

Ordering Information
For popular PC6-TANGO SKUs please refer to www.ekf.com/liste/liste_21.html#PC6
For popular Mezzanine Side Cards please refer to www.ekf.com/liste/liste_20.html#C40

Nomenclature

Signal names used herein with an attached '#' designate active low lines.

Trade Marks

Some terms used herein are property of their respective owners, e.g.

- ▶ Atom™, Apollo Lake (APL): ® Intel
- ▶ CompactPCI, CompactPCI PlusIO, CompactPCI Serial: ® PICMG
- ▶ Windows: ® Microsoft
- ▶ EKF, ekf system: ® EKF

EKF does not claim this list to be complete.

Legal Disclaimer - Liability Exclusion

This manual has been edited as carefully as possible. We apologize for any potential mistake. Information provided herein is designated exclusively to the proficient user (system integrator, engineer). EKF can accept no responsibility for any damage caused by the use of this manual.

Standards

Reference Documents		
Term	Document	Origin
CFast™	CFast™ Specification Rev. 1.0	www.compactflash.org
CompactPCI®	CompactPCI Specification, PICMG® 2.0 R3.0, Oct. 1, 1999	www.picmg.org
CompactPCI® PlusIO	CompactPCI PlusIO Specification, PICMG® 2.30 R1.0, November 11, 2009	www.picmg.org
CompactPCI® Serial	CompactPCI Serial Specification, PICMG® CPCI-S.0 R2.0, June 12, 2015	www.picmg.org
DisplayPort	VESA DisplayPort Standard Version 1.2 December 22, 2009 VESA Mini DisplayPort Connector Standard Ver. 1 October 26, 2009	www.vesa.org
e•MMC	Embedded Multi-Media Card Electrical Standard 5.0/5.1	www.jedec.org
Ethernet	IEEE Std 802.3, 2000 Edition	standards.ieee.org
Precision Time Protocol	IEEE Std 1588-2008, July 24, 2008	standards.ieee.org
LPC	Low Pin Count Interface Specification, Revision 1.1	developer.intel.com/design/chipsets/industry/lpc.htm
HD Audio	High Definition Audio Specification Rev.1.0	www.intel.com/design/chipsets/hdaudio.htm
PCI Express®	PCI Express® Base Specification 3.0	www.pcisig.com
SATA	Serial ATA 3.0 & 3.1 Specification	www.sata-io.org
TPM	Trusted Platform Module 2.0	www.trustedcomputinggroup.org
TXE	Intel® Trusted Execution Engine 3.0	www.intel.com
UEFI	Unified Extensible Firmware Interface UEFI Specification Version 2.5 ACPI Specification Version 6.0	www.uefi.org
USB	Universal Serial Bus 3.0 Specification, Revision 1.0 November 12, 2008	www.usb.org

Overview

The PC6-TANGO is a low power 4HP/3U CompactPCI® PlusIO CPU board, equipped with an Intel® Atom™ E3900-series System-on-Chip processor (Apollo Lake). The front panel is provided with two Gigabit Ethernet jacks (option M12-X), two USB 3.0 receptacles, two DisplayPort connectors, and a Micro SD Card slot.

The PC6-TANGO is equipped with 8GB directly soldered DDR3L ECC RAM, and a CFast™ card socket as on-board SSD mass storage solution.

Optionally available is an on-board 64GByte e•MMC flash memory chip. Further more, low profile SATA SSD mezzanine modules are available as additional on-board mass storage solution. The PC6-TANGO backplane connectors comply with the CompactPCI® PlusIO specification, suitable for system expansion with classic CompactPCI® peripheral cards via J1, and in addition a rear I/O module attached to J2, or up to four CompactPCI® Serial cards accessed on a hybrid backplane.



CompactPCI® PlusIO (PICMG 2.30) is a standard for rear I/O across J2, specified by the PICMG®. High speed signal lines (PCI Express®, SATA, Gigabit Ethernet and USB) are passed from the PC6-TANGO through the special UHM connector to the backplane, for usage either on a PlusIO rear I/O transition module, or CompactPCI® Serial card slots.

CompactPCI® Serial (PICMG CPCIS.0) defines a completely new card slot, based on PCI Express®, SATA, Gigabit Ethernet and USB serial data lines. On a hybrid backplane, both card styles can reside, CompactPCI® and CompactPCI® Serial, with the PC6-TANGO in the middle as system slot controller for both backplane segments.



The PC6-TANGO is provided with a set of local expansion interface connectors, which can be optionally used to attach a mezzanine side board, for additional mass storage or front I/O.

The C48-M2 mezzanine module e.g. is equipped with two M.2 SATA Solid State Drives (SSD), and fits on the PC6-TANGO while maintaining the 4HP front panel profile.

Technical Features

Feature Summary

Feature Summary

General

- ▶ CompactPCI® PlusIO (PICMG® CPCI 2.30) System Slot Controller
- ▶ Form factor single size Eurocard (board dimensions 100x160mm²)
- ▶ Mounting height 3U
- ▶ Front panel width 4HP (8HP/12HP assembly with optional mezzanine side card)
- ▶ Front panel I/O connectors for typical system configuration (2 x USB3, 2 x DisplayPort, 2 x GbE)
- ▶ Backplane communication via CompactPCI® J1 and J2 hard metric connectors
- ▶ J1 Connector for PICMG® CompactPCI® 32-Bit support
- ▶ J2 Connector (UHM high speed) for CompactPCI® PlusIO support (PCIe, SATA, USB, GbE)
- ▶ J2 PlusIO configuration allows for either CompactPCI® Serial backplane usage or rear I/O module attachment
- ▶ On-board 2 x SATA 6G mezzanine expansion option for mass storage modules or side cards
- ▶ Side cards and low profile mass storage modules available as COTS and also as custom specific
- ▶ +5V only board design for low cost system power supply
- ▶ PC6-TANGO can deliver +3.3V to CompactPCI® peripheral boards

Processor

- ▶ Intel® Apollo Lake-I (APL-I) SoC E39xx Series
- ▶ x7-E3950 • 4 Cores • 1.6/2.0GHz • 12W TDP/cTDP • 500/650MHz graphics • 2MB LLC
- ▶ x5-E3940 • 4 Cores • 1.6/1.8GHz • 9.5W TDP/cTDP • 400/600MHz graphics • 2MB LLC
- ▶ x5-E3930 • 2 Cores • 1.3/1.8GHz • 6.5W TDP/cTDP • 400/550MHz graphics • 2MB LLC
- ▶ Graphics Burst, CPU Burst, Intel® Speedstep®
- ▶ Intel® Virtualization Technology (Intel® VT-x / VT-d)
- ▶ Intel® Trusted Execution Engine (Intel® TXE) 3.0

Firmware

- ▶ Phoenix® UEFI (Unified Extensible Firmware Interface) with CSM*
- ▶ Fully customizable by EKF
- ▶ Secure Boot and Measured Boot supported - meeting all demands as specified by Microsoft®
- ▶ Windows®, Linux and other (RTOS)' supported

* CSM (Compatibility Support Module) emulates a legacy BIOS environment, which allows to boot a legacy operating system such as DOS, 32-bit Windows and some RTOS'

Feature Summary

Main Memory

- ▶ Integrated memory controller up to 8GB DDR3L 1600 +ECC
- ▶ Soldered memory for rugged applications

Mass Storage

- ▶ On-board CFast™ Card socket (SATA based CompactFlash)
- ▶ Front I/O Micro SD Card socket (SDHC, SDXC)
- ▶ 128Mbit SPI Flash (UEFI firmware and customer application data)
- ▶ Option e•MMC (embedded MMC 5.0 64GByte soldered)
- ▶ Option low profile mezzanine card C41-CFAST (secondary CFast™ card socket) via P-HSE connector
- ▶ Option low profile mezzanine card C42-SATA (1.8-inch Micro SATA SSD socket) via P-HSE connector
- ▶ Option low profile mezzanine card C47-MSATA (dual mSATA SSD module sockets) via P-HSE connector
- ▶ Option low profile mezzanine card C48-M2 (dual M.2 SATA SSD module sockets) via P-HSE connector
- ▶ Option 8HP assembly side card C44-SATA (2.5-inch SATA SSD/HDD) via P-HSE connector
- ▶ Option custom specific mezzanine board design on request

Graphics

- ▶ Integrated graphics engine, Gen 9 LP
- ▶ DirectX 12.0, OpenCL 2.0 Full Profile, OpenGL 4.3
- ▶ HW media acceleration DXVA 2, VAAPI
- ▶ HW video decode H264 L5.2, H.265 HEVC, VP9, MVC, MPEG2, JPEG/MJPEG, VC1, WMV9, VP8
- ▶ HW video encode H264, SVC, AVC, MVC, MPEG-2
- ▶ Content protection PAVP, HDCP 1.4
- ▶ 2 x DisplayPort front panel connectors
- ▶ DisplayPort™ 1.2a
- ▶ Max Resolution 4096 x 2160 @60Hz

Networking

- ▶ Up to four networking interface controllers (NIC), 1000BASE-T, 100BASE-TX, 10BASE-T connections
- ▶ Intel® I210-IT -40°C to +85°C operating temperature GbE controllers w. integrated PHY
- ▶ IPv4/IPv6 checksum offload, 9.5KB Jumbo Frame support, EEE Energy Efficient Ethernet
- ▶ IEEE 802.1Qav Audio-Video-Bridging (AVB) enhancements for time-sensitive streams
- ▶ IEEE 1588 and 802.1AS packets hardware-based time stamping for high-precision time synchronization
- ▶ Two GbE ports via RJ45 front panel jacks (option 2 x M12-X with mezzanine module P01)
- ▶ Option two GbE ports via backplane connector J2 for rear I/O or CompactPCI® Serial backplane usage

Feature Summary

APL SoC I/O Usage

- ▶ 4 x PCIe Gen2 to J2 backplane connector - usage for CompactPCI® Serial peripheral cards or rear I/O module
- ▶ 1 x PCIe Gen2 to PCIe switch PI7C9X2G606PR 1:5 lanes (on-board PCIe devices)
- ▶ 1 x PCIe to PI7C9X112 PCI bridge (J1 backplane connector, for classic CompactPCI® card support)
- ▶ 1 x SATA 6G to on-board CFast™ SSD card socket - can be used as mass storage and boot device
- ▶ 1 x SATA 6G to mezzanine expansion connector P-HSE
- ▶ e•MMC I/F 400MByte/s (HS400) to embedded MMC 5.0 64GByte (ordering option, mass storage device)
- ▶ 2 x USB 3.0 to front panel connectors
- ▶ 2 x DisplayPort to front panel connectors
- ▶ SDIO (Micro SD Card) front panel slot
- ▶ 4 x USB2 to J2 backplane connector
- ▶ LPC, Audio, I2C, 2 x USB2 to mezzanine expansion connector P-EXP
- ▶ LPC to TPM 2.0 module

On-Board Building Blocks

- ▶ Additional on-board controllers, PCIe® based
- ▶ PCIe® Gen2 packet switch PI7C9X2G606PR (6-port, 6-lane)
- ▶ 2 x Gigabit Ethernet controllers Intel® I210IT (front panel)
- ▶ Option 2 x Intel® I210IT (RIO via J2 backplane connector)
- ▶ PCIe® to PCI® bridge PI7C9X112 (7 x PCI 33/66MHz)
- ▶ Option dual port SATA 6G/3G* controller Marvell® 88SE9170 (to P-HSE mezzanine connector, and J2 RIO)
- ▶ Option e•MMC (embedded MMC 5.0 64GByte HS400)

Security

- ▶ Trusted Platform Module
- ▶ TPM 2.0 for highest level of certified platform protection
- ▶ Infineon Optiga™ SLB 9665 cryptographic processor
- ▶ Conforming to TCG 2.0 specification

- ▶ AES hardware acceleration support (Intel® AES-NI)

Front Panel I/O (4HP)

- ▶ 2 x Gigabit Ethernet RJ45 (2 x I210IT)
- ▶ 2 x DisplayPort (APL SoC)
- ▶ 2 x USB 3.0 Type-A (APL SoC)
- ▶ Micro SD Card slot (APL SoC)

Feature Summary

Front Panel I/O (8HP)

- ▶ Option 2 x M12 X-coded receptacles for Gigabit Ethernet (as replacement for RJ45)

CompactPCI® & CompactPCI® PlusIO Backplane Resources

- ▶ PICMG® CompactPCI® 2.0 CPU card & system slot controller for J1 based 32-bit CompactPCI® systems
- ▶ Support for up to seven CompactPCI® peripheral boards, 33/66MHz (PI7C9X112 PCIe to PCI bridge)
- ▶ PICMG® CompactPCI® 2.30 J2 UHM connector according to CompactPCI® PlusIO
- ▶ J2 can be used to enable CompactPCI® Serial peripheral card slots for hybrid systems with a split backplane
- ▶ J2 can be used alternatively for a rear I/O module
- ▶ J2 is assigned to 4 x PCIe Gen2 5GT/s (from APL SoC), 1 x SATA 6G/3G* (from Marvell SATA controller), 4 x USB2 ports (from APL SoC), 2 x Gigabit Ethernet (optional I210IT networking controllers)

** CompactPCI® PlusIO specifies SATA 3G over J2. SATA 6G may be functional but is not guaranteed. The Marvell SATA RAID controller port available via J2 is therefore configured for 3Gbps by default.*

Local Expansion

- ▶ Mezzanine side card connectors for optional local expansion
- ▶ P-EXP - LPC, Audio, 2 x USB2, I2C, UART Rx/Tx (from APL SoC)
- ▶ P-HSE - 2 x SATA 6G (port 1 from APL SoC, port 2 from optional PCIe to SATA controller 88SE9170)
- ▶ 4HP Low profile mezzanine module options (to be ordered separately)
- ▶ CFast™ Card with C41-CFAST mezzanine module
- ▶ SATA 1.8-Inch Solid State Drive with C42-SATA mezzanine module
- ▶ Dual mSATA SSD with C47-MSATA mezzanine module
- ▶ Dual M.2/NGFF SATA SSD 2230 - 2280 size with C48-M2 mezzanine module
- ▶ Custom specific module design
- ▶ 8HP Mezzanine side card option (to be ordered separately)
- ▶ 2.5-inch SATA SSD/HDD available with C44-SATA
- ▶ Side cards available with LPC Super I/O functionality (e.g. to be used for UART RS-232)
- ▶ Custom specific side card design

Feature Summary

Environmental & Regulatory

- ▶ Suitable e.g. for industrial, transportation & instrumentation applications
- ▶ Designed & manufactured in Germany
- ▶ ISO 9001 certified quality management
- ▶ Long term availability
- ▶ Rugged solution
- ▶ Coating, sealing, underfilling on request
- ▶ Lifetime application support
- ▶ RoHS compliant
- ▶ Operating temperature 0°C to +70°C
- ▶ Operating temperature -40°C to +85°C (industrial temperature range) on request
- ▶ Storage temperature -40°C to +85°C, max. gradient 5°C/min
- ▶ Humidity 5% ... 95% RH non condensing
- ▶ Altitude -300m ... +3000m
- ▶ Shock 15g 0.33ms, 6g 6ms
- ▶ Vibration 1g 5-2000Hz
- ▶ MTBF 11.2 years
- ▶ EC Regulatory EN55022, EN55024, EN60950-1 (UL60950-1/IEC60950-1)

RT OS Board Support Packages & Driver

- ▶ Please refer to external document www.ekf.com/s/rtos_support.pdf

Applications

- ▶ General low power industrial computing, for x86 based software
- ▶ Rugged systems (e.g. transportation)
- ▶ Data concentrator, router, gateway, kiosk systems
- ▶ Stand-alone computer (edge computing), mezzanine and rear I/O expansion options
- ▶ Small modular systems, CompactPCI® and/or CompactPCI® Serial peripheral card expansion

Power Requirements

Power Requirements		
Board SKU	Load Current [A] at +5V (+0.25V/-0.15V)	
	Maximum Performance LFM / HFM / Turbo ¹⁾	Windows 10 Idle LFM / HFM / Turbo ¹⁾
PC6-tbd		
PC6-tbd		
PC6-tbd		

¹⁾ Intel SpeedStep Frequency Modes LFM: Low Frequency Mode, HFM: High Frequency Mode

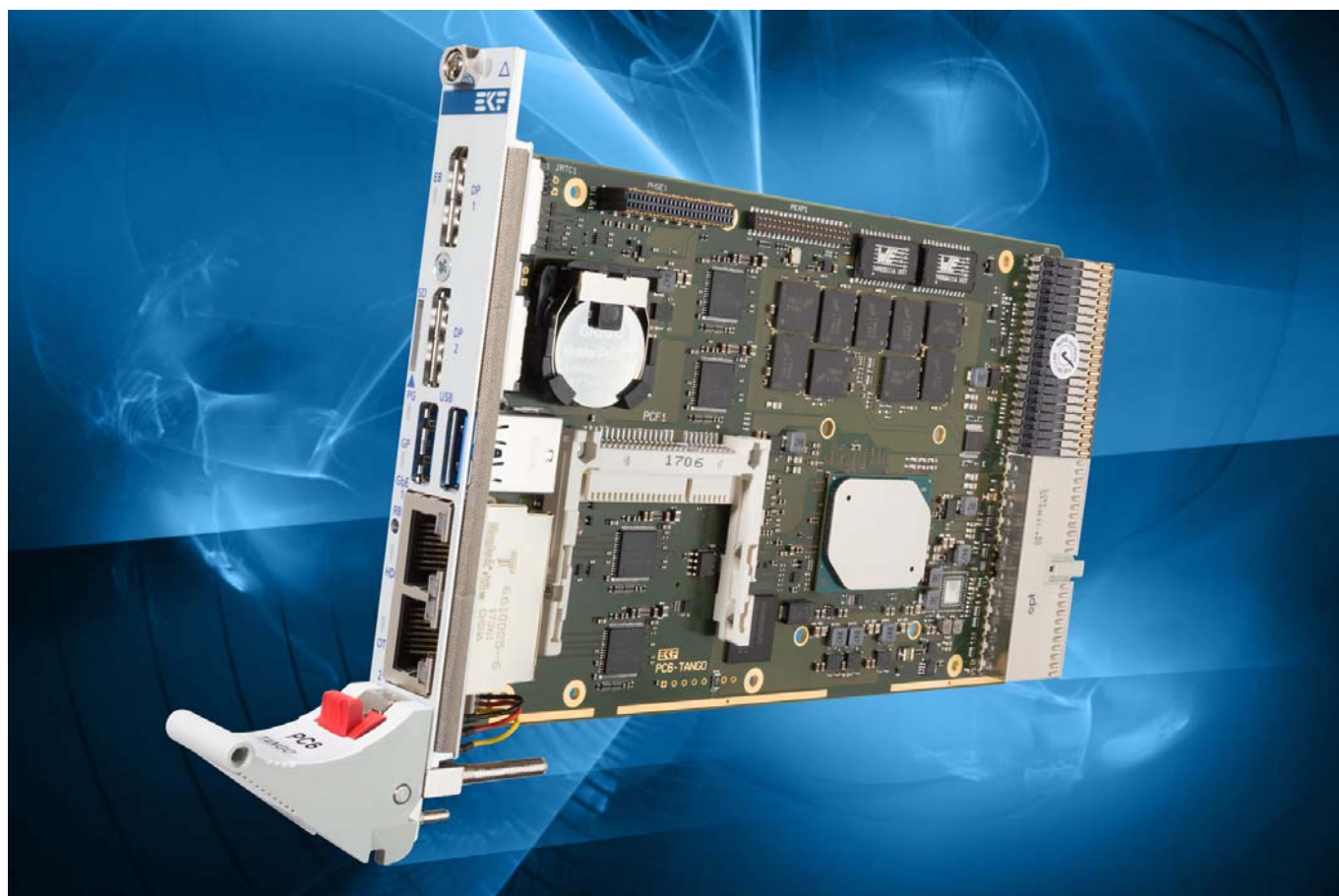

Top View Component Assembly

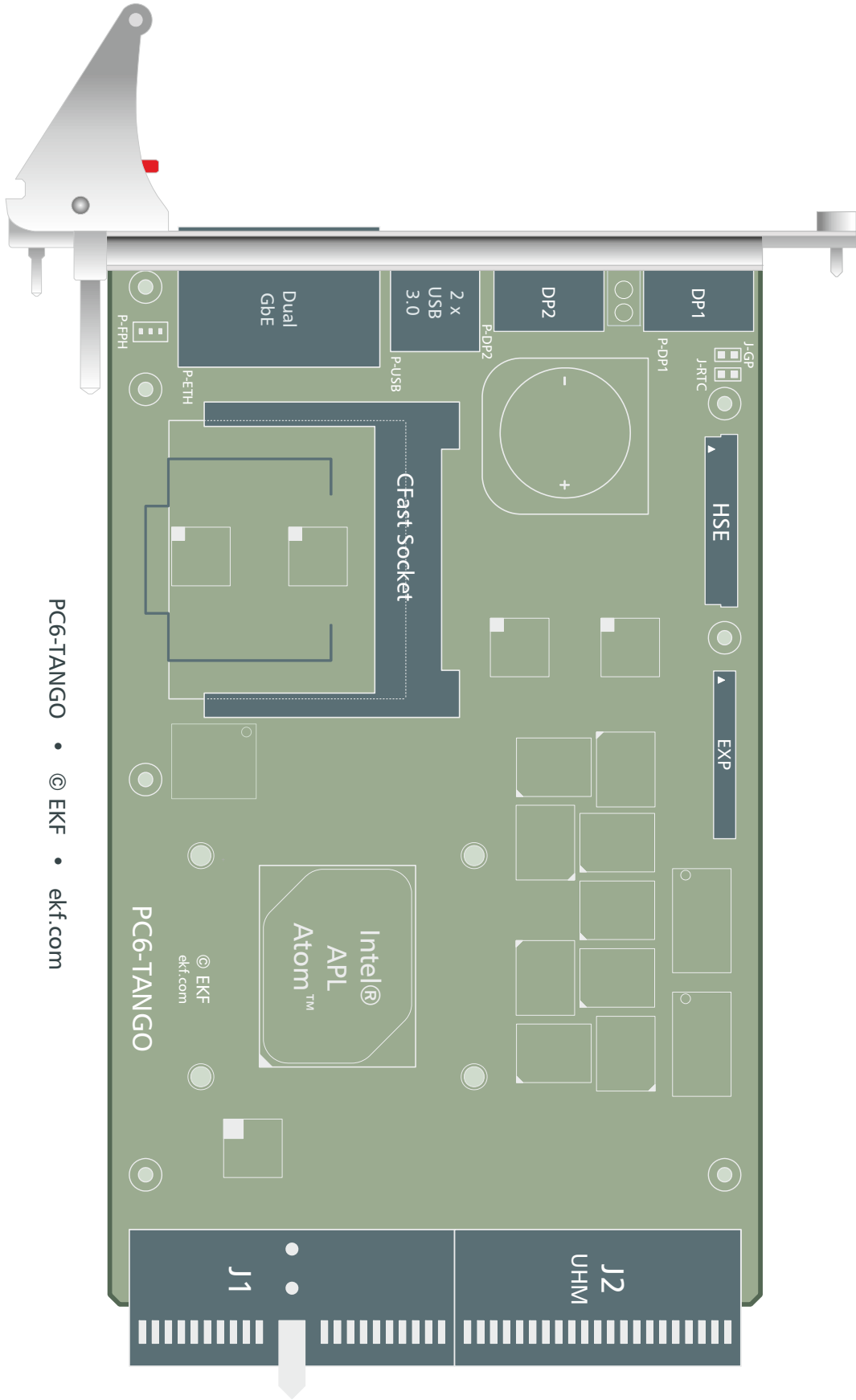

Bottom View Component Assembly

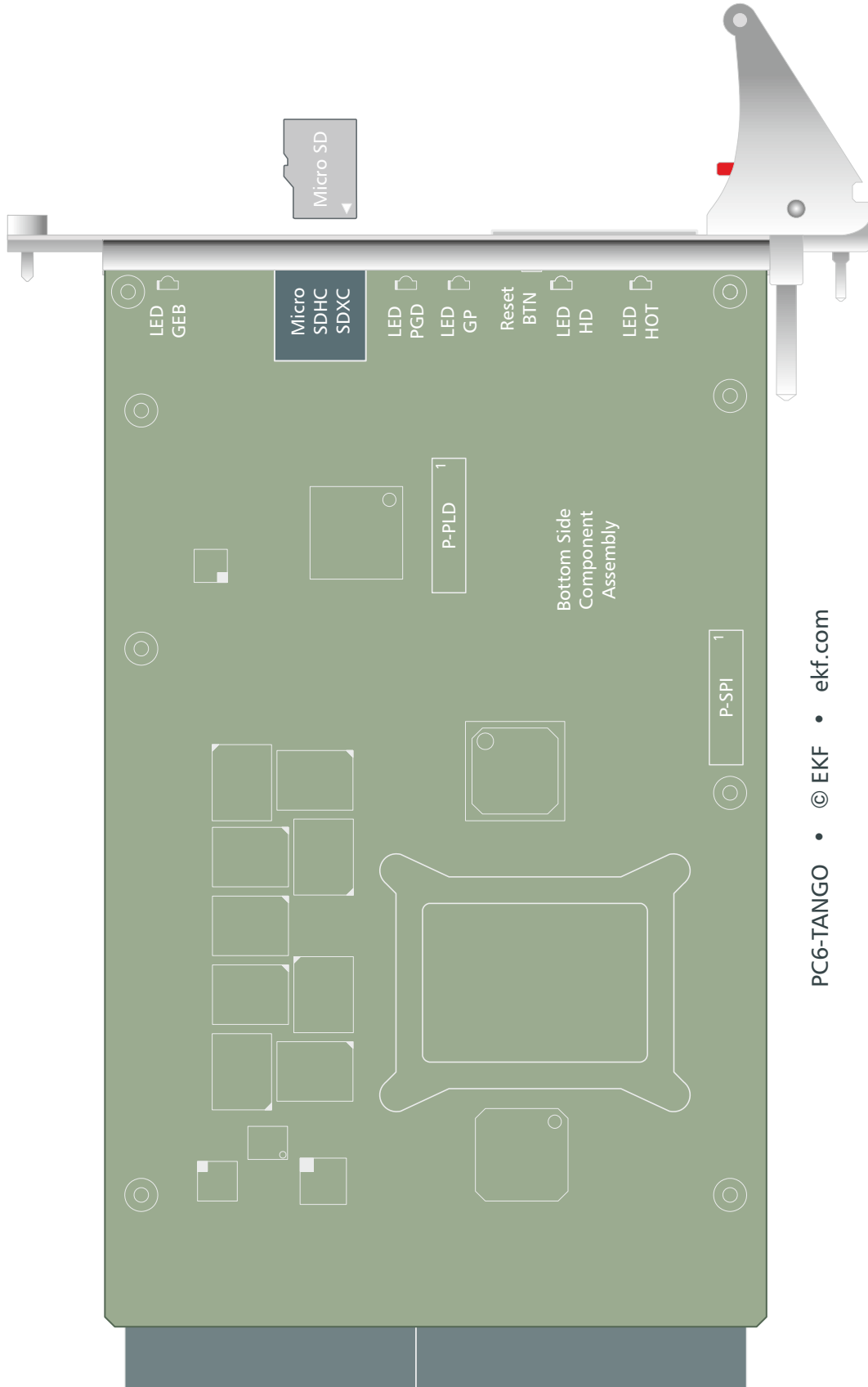

PC6-TANGO • © EKF • ekf.com

Front Panel Connectors

ETH1/2	Dual Gigabit Ethernet RJ-45 receptacles with integrated indicator LEDs (Option M12-X)
DP1/2	DisplayPort digital video output receptacles
USB1/2	Universal Serial Bus 3.0 stacked type A receptacles (USB 3.1 Gen1 5Gbps)
Micro SD	Micro SD Card slot push-push type

Front Panel Switches & Indicators

EB	LED indicating Backplane Ethernet activity
FPH	Front Panel Handle with integrated switch (programmable function, power event button by default)
GP	General Purpose bicolour LED
HD	Bicoloured LED indicating any activity on SATA ports
HOT	LED signalling a CPU over temperature
PG	Power Good/Board Healthy bicolour LED
RB	System Reset Button (Option)

On-Board Connectors & Sockets

CFAST	Socket for CFast™ Card (6G SATA SSD)
P-EXP	Utility EXPansion interface connector (LPC, USB, HD Audio, SMBus), interface to optional side board
P-HSE	High Speed Expansion connector 1 x SATA 6G interface to optional low profile mezzanine module or side board (2 x SATA 6G option)
J1	CompactPCI® Bus 32-bit (universal V(I/O)), 33/66MHz, supports up to 7 peripheral card slots
J2	CompactPCI® PlusIO for rear I/O usage or CompactPCI® Serial peripheral card slots, support for 4 x PCI Express® Gen2, 4 x USB 2.0, 1 x SATA 6G (option), 2 x GbE (option)
P-MIPI	CPU debug port ¹⁾

¹⁾ Connector populated on customers request only

Pin Headers

P-FPH	Pin header suitable for front panel handle switch cable harness
P-PLD	PLD glue logic device programming connector, not populated
P-SPI	SPI Flash device programming connector, not populated

Jumpers

J-GP	Jumper to reset UEFI/BIOS setup to EKF factory defaults, IEEE 1588 Pulse per Second output
J-MFG	Jumper to enter manufacturing mode, not populated
J-RTC	Jumper to reset RTC circuitry (part of SoC), not populated

Microprocessor

The PC6-TANGO is equipped with an Intel® Atom™ E39xx series processor (code name Apollo Lake-I aka 'APL-I'). This system-on-chip (SoC) provides integrated graphics, an ECC memory controller and high speed I/O, resulting in a low power platform design. As of current, Intel® offers three CPU SKU versions suitable for the PC6-TANGO, differing mainly in the power consumption, caused by differences in the number of processor cores integrated and internal clock speed.

The processor is housed in a FCBGA-1296 package for direct soldering to the PCB, i.e. the chip cannot be removed or changed by the user.

Power is applied across the CompactPCI® connector J1 (5V). The processors core, graphics and memory voltages are generated by switched voltage regulators sourced from the 5V plane.

Intel® Atom™ Processors Supported						
Processor Number	Physical Cores	Core Clock L/H/B [GHz]	Cache [MB]	Gfx Clock L/H/B [MHz]	T _{CASE} max. [°C]	TDP/ cTDP [W]
x7-E3950	4	0.8/1.6/2.0	2	100/500/650	98	12
x5-E3940	4	0.8/1.6/1.8	2	100/400/600	100	9.5
x5-E3930	2	0.8/1.3/1.8	2	100/400/550	103	6.5

L = Lowest Frequency Mode

H = Highest Frequency Mode

B = Boost (Turbo Mode)

Please note: Intel® recommends a GPU clock of 400MHz for industrial applications

T_{CASE} is the temperature measured on top of the APL heat spreader (T_j max. = 110°C)

Minimum T_{CASE} is -40°C

Thermal Considerations

The PC6-TANGO is equipped with a passive heatsink. Its height takes into account the 4HP envelope of a CompactPCI® board. Dependent on the targeted APL-I SoC SKU and ambient temperature, many applications may not require additional cooling.

However, a reasonable forced vertical airflow through the system enclosure (e.g. bottom mount fan unit) may be required for demanding applications and for higher ambient temperatures. The maximum temperature on top of the CPU case must not exceed 100°C e.g. for the E3940.

The APL E3900 Atom™ processors support Intel's Enhanced SpeedStep® technology, enabling dynamic switching between multiple core voltages and frequencies depending on core temperature and currently required performance. The processors are able to reduce their core speed and core voltage in multiple steps down. Additionally a reduction of the graphics core clock and voltage is possible. This results in a reduction of power consumption and heat dissipation.

Do not try to remove the PC6-TANGO heatsink by yourself, since it is bonded to the CPU by a Phase-Change-Material (PCM), in order to improve the heat flow between the APL and the heatsink.

Main Memory

The PC6-TANGO features a total of 8GB DDR3L SDRAM with support of ECC (Error Correction Code). 8GB is the maximum memory size supported by the APL-I SoC. All 18 memory devices are directly soldered to the board (Memory Down), with a clock frequency of 1600MHz.

You may find external documents which specify a maximum DDR3L speed of 1866MT/s for the APL. However, this is valid for non ECC designs only.

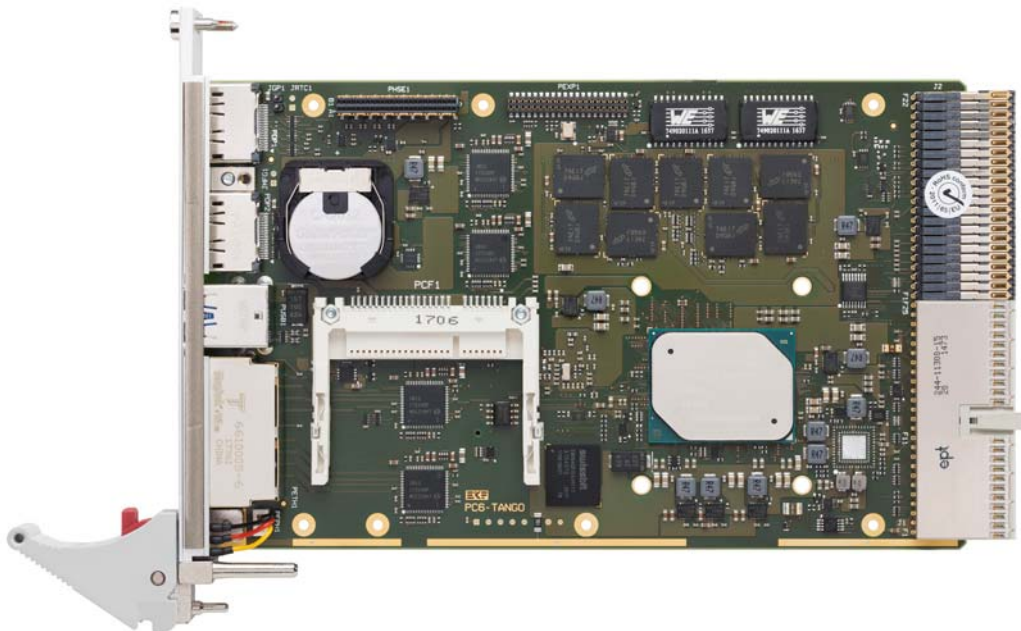

Graphics Subsystem

The APL-I SoC is provided with an integrated GPU, running at up to 650MHz clock, based on the 9th generation Intel® graphics. For industrial applications and optimum reliability however, Intel® recommends to operate the GPU at 400MHz fixed clock.

The PC6-TANGO offers two DisplayPort (DP) receptacles in the front panel, for individual use or an extended desktop application. The VESA DDC standard is supported, allowing to read out important display parameters, e.g. the maximum supported resolution from the attached monitor. DDC power +3.3V is delivered via electronic switches to protect the board from an external short-circuit condition (1.5A) and to prevent back driving current flows.

Graphics drivers for the Intel® GPU are an inherent part of popular operating systems, or can be downloaded from the Intel® website.

LAN Subsystem

The Ethernet LAN subsystem is comprised of up to four Gigabit Ethernet ports. Two Intel® i210IT Gigabit Ethernet controllers are provided to support the front panel RJ45 jacks (backwards compatible to 10Base-T and 100Base-TX). Another two i210IT NICs are available as an option, for rear I/O usage via the J2 backplane connector. Each port includes the following features:

- ▶ 1000Base-Tx (Gigabit Ethernet), 100Base-TX (Fast Ethernet) and 10Base-T (Classic Ethernet) capability
- ▶ Half- or full-duplex operation
- ▶ IEEE 802.3u, 802.3ab Auto-Negotiation for the fastest available connection
- ▶ Jumperless configuration (complete software-configurable)

Two bicoloured LEDs integrated into the dedicated RJ-45 connector in the front panel are used to signal the LAN link, the LAN connection speed and activity status. A further bicoloured LED in front panel labelled EB displays the state of the optional backplane network ports.

Due to limited internal resources of the APL, each GbE NIC device is connected via its PCI Express® lane to an on-board PCI Express® 1:5 port packet switch (Diodes PI7C9X2G606PR), thus sharing a common PCIe Gen2 lane (5Gbps) from the APL-I SoC. With its 5Gbps uplink, the PCIe switch can smoothly control all four GbE NICs simultaneously at maximum networking speed. However, across its remaining downstream port the PCIe switch would also feed an optional on-board SATA 6G controller. For applications which use this hardware configuration intensely, a loss in networking performance may temporarily occur.

The MAC addresses (unique hardware number assigned to any Ethernet NIC) are stored in dedicated FLASH/EEPROM components.

The Intel Ethernet software and drivers for the i210IT are available for download from Intel®.

Any of the i210IT controllers supports the IEEE 1588 Precision Time Protocol, important for TSN (Time Sensitive Networking) applications. In addition, the first NIC (which is connected to the upper RJ45 jack within the front panel) is configured to generate Pulse per Second (PPS) and Pulse per Minute (PPM) signals for output via the jumper J-GP and to the backplane connector J2. These signals can be used to trigger events on external hardware such as mezzanine side boards or peripheral cards. The following routing can be enabled by UEFI/BIOS settings:

- ▶ Pulse per Second (PPS): J-GP Pin 1 and CompactPCI® J2 (signal SATA-SCL J2-D14)
- ▶ Pulse per Minute (PPM): CompactPCI® J2 (signal SATA-SDO J2-D13)

Serial ATA Interface (SATA)

The PC6-TANGO provides a total of up to four serial ATA (SATA) 6Gbps ports, suitable for attachment of mass storage devices. Two ports are derived directly from two the APL-I SoC; another two ports are available as an option via an on-board SATA controller.

The APL SATA port P0 is in use for an on-board CFast™ connector. CFast™ cards are available up to 512GB storage capacity as of current, sufficient for typical operating system installation and application programs.

The APL SATA port P1 is wired to the mezzanine connector HSE, for optional usage with a low profile mezzanine module such as the C48-M2 (M.2 SATA SSD storage).

As an option, the PC6-TANGO can be equipped with a discrete on-board SATA controller in addition, providing another two SATA 6Gbps ports. The Marvell 88SE9170 is an SATA 6Gbps I/O controller, connected to the system via PCI Express®. One of the 88SE9170 SATA ports is wired to the mezzanine connector HSE, and the other to the backplane connector J2. The 88SE9170 shares a common PCIe lane from the APL SoC with the on-board NIC devices, by means of a PCI Express® packet switch. Therefore the maximum throughput of the 88SE9170 SATA ports may be somewhat reduced compared to the APL native SATA ports.

As mentioned, a single SATA port is used to supply the CompactPCI® PlusIO SATA interface on the backplane or rear I/O module, via the J2 UHM connector. Please note, that the CompactPCI® PlusIO specification refers to SATA data rates of 1.5Gbps and 3Gbps. EKF has tested successfully also 6G over the backplane with sample devices, but cannot guarantee this data rate under any condition. Other devices and other backplane brands/types in use may cause a different result. If in doubt, the Marvell SATA controller should be initialized for 3Gbps. EKF recommends that customers validate their particular SATA 6G application thoroughly, since SATA channel data errors can decrease the performance considerably.

A bicolor LED named HD located in the front panel, signals the activity status of any APL SATA device (green) or 88SE9170 SATA device (yellow).

Windows® drivers and software for the 88SE9170 is provided by Marvell and can be downloaded from the EKF website.

PCI Express® Interface

The PC6-TANGO is provided with four PCI Express® (PCIe) Gen 2 lanes for rear I/O expansion, derived from the APL-I SoC (PCIe P0-P3), and available via the backplane connector J2. By software strapping, these lanes can be configured as 4 PCIe links x1, or one link x4, for use on a hybrid backplane with CompactPCI® Serial peripheral slots, or on a rear I/O module.

Another two PCI Express® lanes from the APL-I SoC are in use on-board.

The APL PCIe lane P4 is used as upstream port for an 1:5 PCIe packet switch, which controls all four i210IT GbE controllers, and in addition an optional SATA controller.

The APL PCIe lane P5 is connected to the PCIe to PCI bridge, which allows to control up to eight CompactPCI® Classic peripheral slots across the backplane connector J1.

Universal Serial Bus (USB)

The APL-I SoC on the PC6-TANGO is configured to support two USB 3.1 Gen1 Type-A front panel connectors (USB 3.1 was formerly known as USB 3.0 5Gbps SuperSpeed). Both front panel USB receptacles can source a minimum of 1.5A/5V each, over-current protected by electronic switches.

Another four USB 2.0 ports are available across the backplane connector J2, for rear I/O usage, or on a CompactPCI Serial peripheral card slot. In addition, two more USB 2.0 ports are wired to the legacy mezzanine connector P-EXP, for optional usage on side cards.

Utility Interfaces

Besides the high speed mezzanine interface connector P-HSE, the PC6-TANGO is provided with the utility interface expansion connector P-EXP, which comprises several legacy interfaces, which may be useful for system expansion on mezzanine cards:

- ▶ HD Audio
- ▶ LPC (Low Pin Count) @ 25MHz clock
- ▶ I2C
- ▶ 2 x USB 2.0
- ▶ UART Rx/Tx

All signals are controlled by the APL-I SoC. The I2C signals on P-EXP are derived from the APL I2C port 0 and not shared with any other components on the PC6-TANGO, thus avoiding any potential I²C address conflict.

The HD Audio port requires an additional audio codec, as provided e.g. on the PCS-BALLET side card.

The LPC bus presents an easy way to add legacy interfaces to the system. EKF offers a variety of mezzanine expansion boards (side cards), to be attached on top of the PC6-TANGO, featuring all classic Super-I/O functionality, for example the PCS-BALLET. Access to the side card connectors PS/2 (mouse, keyboard), COM, USB and audio in/out is given directly from the common 8HP front panel.

The LPC I/F is shared with the TPM (Trusted Platform Module) on the PC6-TANGO. Some side cards however may be also equipped with a TPM device, which would result in a conflict. For usage together with the PC6-TANGO, side cards must be ordered w/o a TPM soldered.

The USB 2.0 ports can be used on a mezzanine side card for front I/O, or for on-board devices.

A lean UART I/F is also available via the P-EXP connector, comprised of Rx and Tx (TTL level signals) only. It can be used for processor debug, or customer application. External transceivers to RS-232 or RS-485 would have to be added, and in-band data flow control (XON/XOFF) should be setup.

Real-Time Clock

The PC6-TANGO is provided with a time-of-day clock and 100-year calendar, integrated into the APL-I SoC. A battery on the board supplies the clock circuitry whenever the computer main power is turned off. The PC6-TANGO uses a holder to retain a BR2032 lithium coin cell, giving an autonomy of more than 5 years.

Alternately a leaded BR2032 battery can be soldered directly to the board for increased ruggedness, or if the PC6-TANGO PCB shall be coated.

In applications where the use of a battery is not permitted, a SuperCap can be soldered instead of the battery.

SPI Flash

The UEFI/BIOS firmware is stored in a flash device, attached via the Serial Peripheral Interface (SPI). Up to 16MByte of code, firmware and user data may be stored nonvolatile here.

The SPI Flash contents can be updated by a DOS or Linux based tool. This program and the latest PC6-TANGO UEFI/BIOS binary are available from the EKF website. Read carefully the enclosed instructions. If the programming procedure fails e.g. caused by a power interruption, the PC6-TANGO may no more be operable. In this case you would have to send in the board, because the Flash device is directly soldered to the PCB and cannot be changed by the user.

CFast™

The PC6-TANGO is provided with a CFast™ host connector, for user replaceable mass storage. It is suitable for CFast™ 2.0 cards, which have the same dimensions as CompactFlash™ cards, but are operated in SATA mode. Industrial CFast™ SSD cards are available up to 256GByte as of current. The SATA channel available on the CFast™ socket is derived directly from the APL-I SoC. A CFast™ card can be used as boot device (i.e. OS installation) in most applications.

e•MMC

The PC6-TANGO can be equipped with an Embedded Multi-Media Card (e•MMC) as an option. This is a fast Flash based storage solution which has been proved in mobile devices. The chip is soldered directly to the board, with a capacity of 64GByte as of current. The interface is specified by a Jedec standard, and is directly controlled from the APL-I SoC. The e•MMC may be useful for permanent data storage and small OS installation, since its 8-bit data bus is operated in a high speed mode (HS400) for sequential read up to 250MBps.

Micro SD Card

For removable data storage, the PC6-TANGO provides a Micro SD Card socket, accessible through the front panel. Industrial Micro SDHC cards are available up to 32GByte, sufficient for permanent data storage at reasonable transfer speed in many applications. The Micro SD Card socket is controlled immediately by the APL-I SoC (SDIO I/F).

Reset

The PC6-TANGO is provided with a supervisor circuit to monitor supply rails like the CPU core voltage, DDR3L supply voltage 1.35V, 1.05V, 3.3V or 5V.

To force a manual board reset, the PC6-TANGO offers a small tactile switch within the front panel. This push-button is indent mounted and requires a tool, e.g. a pen to be pressed, preventing from being inadvertently activated.

The handle within the front panel contains a micro switch that is used to generate a power button event. By pressing the handle's red push button a pulse is triggered.

Animated GIF: www.ekf.com/c/ccpu/img/reset_400.gif

NOTE: To prevent the board from causing a power button override, the handle should be closed again immediately after unlocking the front panel handle. A power button override is triggered by opening the front panel handle for at least 4 seconds, which results in bringing the board to power state S4/S5. In case of entering this state, unlock and lock the front panel handle a 2nd time to reenter normal power state S0 again. See also section 'PG (Power Good) LED' to see how the PC6-TANGO indicates the different power states.

WARNING: The PC6-TANGO will enter the power state S4/S5 if the front panel handle is not closed properly when the system powers up. An open handle is signalled by a yellow blinking 'PG LED'.

The function of the micro switch within the handle could be changed from "power button" to "system reset" by UEFI/BIOS settings. In this case the front panel handle behaves like the tactile switch.

The manual reset push-button and the functionality of the front panel handle could also be disabled by UEFI/BIOS settings.

An alternative (and recommended) way to generate a system reset is to activate the signal PRST# located on CompactPCI® PlusIO connector J2 pin C17. Pulling this signal to GND will have the same effect as to push the tactile reset switch.

The healthy state of the PC6-TANGO is indicated by the LED PG (Power Good) located in the front panel. This bicoloured LED signals different states of the board (see section below). As soon as this LED begins to lite green, all power voltages are within their specifications and the reset signal has been deasserted.

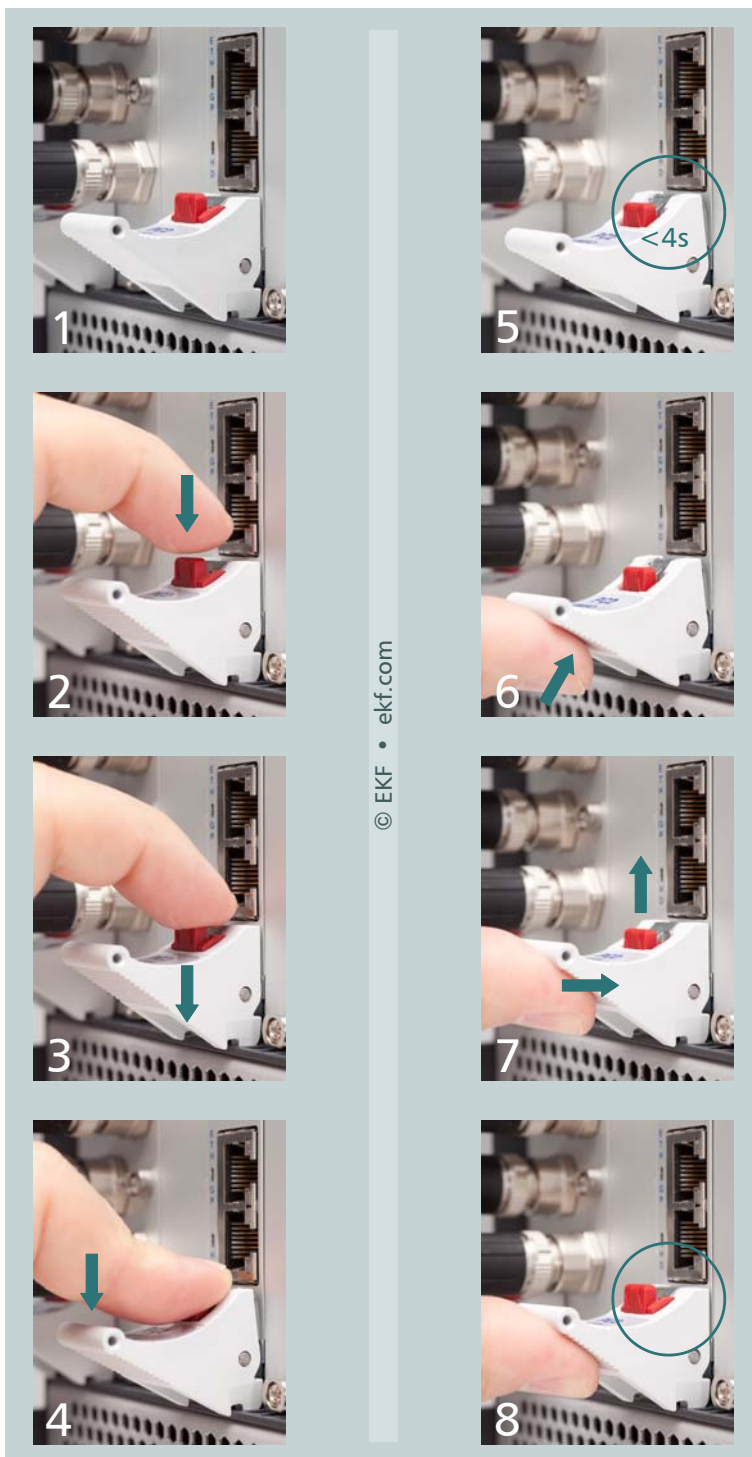

Watchdog

An important reliability feature is a software programmable watchdog function. The PC6-TANGO contains two of these watchdogs. One is part of the APL-I SoC and also known as TCO Watchdog. A detailed description is given in the Apollo Lake data sheet. Operating systems like Linux offer a driver interface to the TCO watchdog.

The behaviour of the 2nd watchdog is defined within a PLD of the PC6-TANGO, which activates/deactivates the watchdog and controls its time-out period. The time-out delay is adjustable in the steps 2, 10, 50 and 255 seconds. After alerting the WD and programming the time-out value, the related software (e.g. application program) must trigger the watchdog periodically. For details on programming the watchdog see section "Board Control and Status Register (BCSR)".

This watchdog is in a passive state after a system reset. There is no need to trigger it at boot time. The watchdog is activated on the first trigger request. If the duration between two trigger requests exceeds the programmed period, the watchdog times out and a full system reset will be generated. The watchdog remains in the active state until the next system reset. There is no way to disable it once it has been put on alert, whereas it is possible to reprogram its time-out value at any time.

Front Panel LEDs

The PC6-TANGO is equipped with five LEDs which can be observed from the front panel. Three of these LEDs are labelled according to their primary meaning, but should be interpreted altogether for system diagnosis:

LED			Status
PG Green/Red	GP Green/Red	HD Green/Yellow	
OFF	GREEN	OFF	Sleep State S4/S5 (Suspend to Disk/Hibernate/Soft Off)
OFF	OFF	GREEN	Sleep State S3 (Suspend to RAM/Standby)
GREEN	RED BLINK	X	After Reset
GREEN	X	X	Board Healthy and in S0 State
YELLOW BLINK	X	X	Front panel handle is unlocked
RED	X	X	Hardware Failure - Power Fault
RED BLINK	X	X	Software Failure

PG (Power Good) LED

The PC6-TANGO offers a bicolour LED labelled PG located within the front panel. After system reset, this LED defaults to signal different power states:

- ▶ Off Sleep state S3 or S4/S5
- ▶ Green Healthy
- ▶ Yellow blink Front panel handle open
- ▶ Red steady Hardware failure
- ▶ Red blink Software failure

To enter the PG LED state *Software Failure*, the bit PGLED in the board control register CTRL_REG must be set. The PG LED remains in this red blinking state until this bit is cleared. After that it falls back to its default function.

GP (General Purpose) LED

This programmable bicolour LED can be observed from the PC6-TANGO front panel. The status of the red part within the LED is controlled by the GPIO16 of the APL-I SoC. Setting GPIO16 to "1" will switch on the red LED. Turning on or off the green LED is done by setting the bit GPLED in the board control register CTRLH_REG.

The GP LED is not dedicated to any particular hardware or firmware function with exception of special power states of the LED PG as described above. Nevertheless, a red blinking GP LED is an indication that the UEFI/BIOS code couldn't start.

While the CPU card is controlled by the UEFI/BIOS firmware, the GP LED is used to signal board status information during POST (Power On Self Test). After successful operating system boot, the GP LED may be freely used by customer software. For details please refer to www.ekf.com/p/pc6/firmware/fwinfo.txt.

HD (Hard Disk Activity) LED

The PC6-TANGO offers a bicoloured LED marked as HD¹⁾ placed within the front panel. This LED, when blinking green, signals activity on any device attached to the SATA ports of the APL-I SoC.

The yellow part of the HD LED shows activity on any of the optional 88SE9170 SATA controller ports.

As previously described, the green part of this LED may change its function dependent on the state of the LED PG.

¹⁾ The assignment HD was maintained as a synonym for CPU card mass storage - needless to say that most applications would be equipped with SSD devices instead.

EB (Ethernet Backplane) LED

To monitor the link status and activity on both Ethernet ports attached to the backplane via the CompactPCI® PlusIO connector J2 a single bicoloured LED is provided in the front panel. The states are decoded as follows:

1_ETH	2_ETH	LED EB
no link	no link	OFF
link	no link	GREEN
no link	link	YELLOW
link	link	GREEN/YELLOW

Blinking of the LED EB in the appropriate colour means that there is activity on the port.

The backplane Ethernet ports are offered as an PC6-TANGO option.

Hot Swap Detection

The CompactPCI® specification added the signal ENUM# to the PCI bus to allow board hot swapping. This signal is routed to a GPIO (ISH GPIO7 APL-I SoC) . An interrupt can be requested, if ENUM# changes, caused by insertion or removal of a peripheral board.

Note that the PC6-TANGO itself is not a hot swap device, because it makes no sense to remove the system controller from a CompactPCI® system. However, it is capable to recognize the hot swap of peripheral boards and to start software that is performing any necessary system reconfiguration.

Power Supply Status (PWR_FAIL#)

Power supply failures may be detected before the system crashes down by monitoring the signals DEG# or FAL#. These active low lines are additions to the CompactPCI® specification and may be driven by the power supply. DEG# signals the degrading of the supply voltages, FAL# there possible failure. On the PC6-TANGO DEG# is pulled to VCC and FAL# is routed to APL-I SoC GPIO17.

As an option a circuit can be stuffed on PC6-TANGO to use this signal as an output to drive PSON# of a power supply. With this option and the related external wiring it is possible to switch off the main power supply when the system powers down to state S4. To restart the system, the PSON# line must be pulled down manually for a second approximately, e.g. by an external push-button.

The use of this signal as PWR_FAIL# or PSON# is mutually exclusive.

Mezzanine Side Board Options

The PC6-TANGO is provided with several stacking connectors for attachment of a mezzanine expansion module (aka side board), suitable for a variety of readily available mezzanine cards (please refer to www.ekf.com/c/ccpu/mezz_ovw.pdf for a more comprehensive overview). EKF furthermore offers custom specific development of side boards (please contact sales@ekf.de).

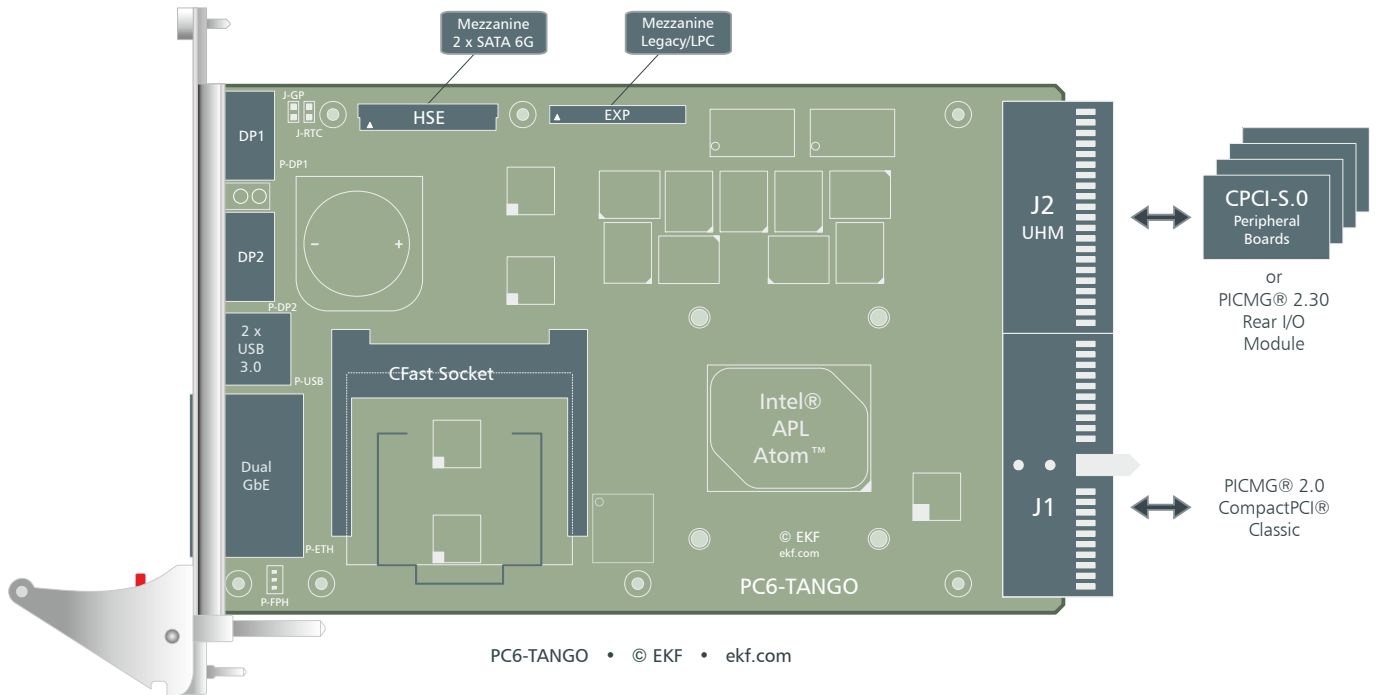

PC6-TANGO • System Expansion Options

Most mezzanine expansion modules require an assembly height of 8HP in total, together with the CPU carrier board (resulting from two cards at 4HP pitch each). In addition, cropped low profile mass storage mezzanine modules can be attached to P-HSE, which maintain the 4HP envelope, for extremely compact systems.



Sample Low Profile Mezzanine Module 4HP Assembly



Sample Mezzanine Side Card 8HP Assembly

P-EXP	
I/F Type	Controller
LPC (Low Pin Count)	APL-I SoC
HD Audio	APL-I SoC
I2C	APL-I SoC (I2C Port 0)
2 x USB 2.0	APL-I SoC
UART Rx/Tx TTL	APL-I SoC (UART Port 0)

P-HSE	
I/F Type	Controller
SATA1	APL-I SoC (Port 1)
SATA2 (Option)	Option 88SE9170 SATA Controller (Port 0)

CompactPCI® PlusIO

CompactPCI® PlusIO (PICMG® 2.30) is a standard for rear I/O across J2. High speed signal lines (PCI Express®, SATA, Gigabit Ethernet and USB) are passed from the PC6-TANGO through the special UHM J2 connector to the backplane, for usage either with a PlusIO rear I/O transition module, or CompactPCI® Serial card slots.

CompactPCI® Serial (PICMG® CPCIS.0) defines a completely new card slot, based on PCI Express®, SATA, Gigabit Ethernet and USB serial data lines. On a hybrid backplane, both card styles can reside, CompactPCI® and CompactPCI® Serial, with the PC6-TANGO in the middle as controller for both backplane segments.

The PC6-TANGO can be used in any system with a CompactPCI® PlusIO backplane according to the PICMG® 2.30 specification. Hybrid backplanes allow the configuration of systems with CompactPCI® Serial slots in addition to classic CompactPCI® boards.

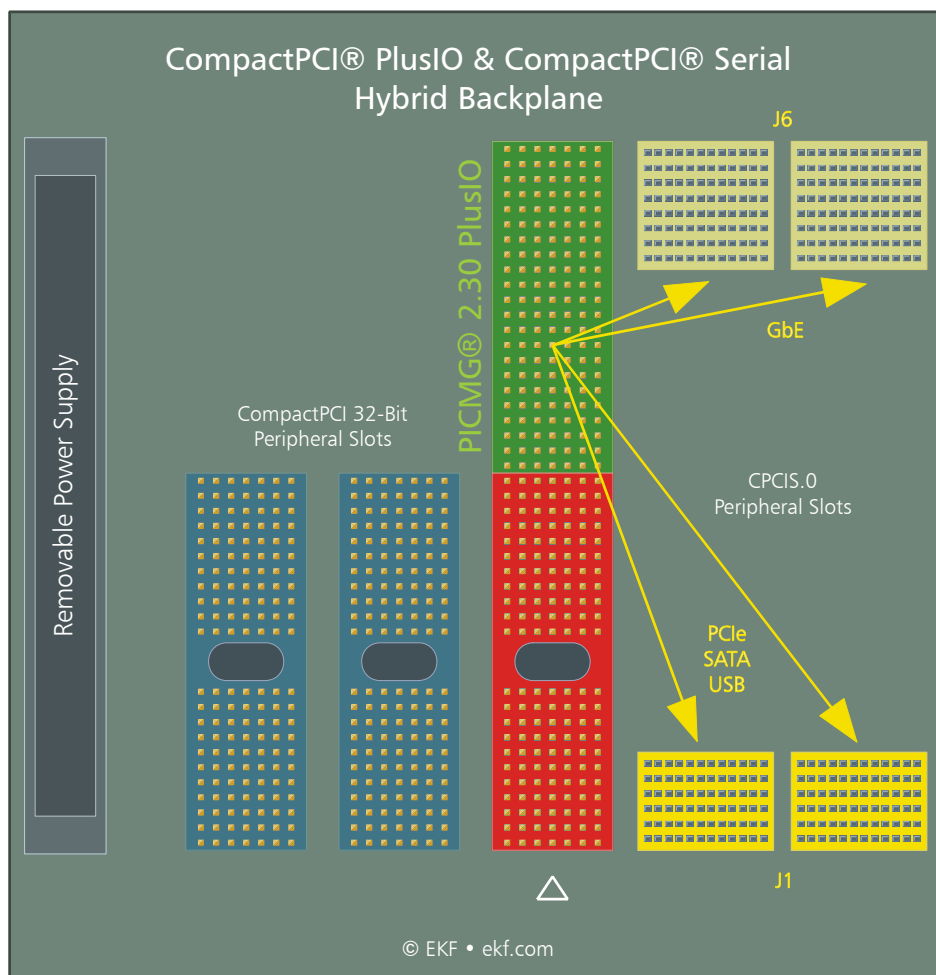

Sample Small Systems Hybrid Backplane

As an alternate to a hybrid backplane, the PC6-TANGO can be combined with a CompactPCI® PlusIO rear I/O transition module.

Warning:

Do not operate the standard PC6-TANGO in systems with a 64-bit CompactPCI® backplane. The J2/P2 pin assignment of a 64-bit CPCI backplane differs substantially from a CompactPCI® PlusIO backplane, which will result in an overvoltage or short circuit situation on several pins, causing permanent damage to the PC6-TANGO. For use together with a 64-bit CompactPCI® classic backplane, special PC6-TANGO versions are available on customer request, however supporting only 32-bit peripheral cards. The use of 64-bit CompactPCI® classic peripheral boards may cause problems.



CompactPCI® PlusIO CPU Card as System Controller in a Hybrid System

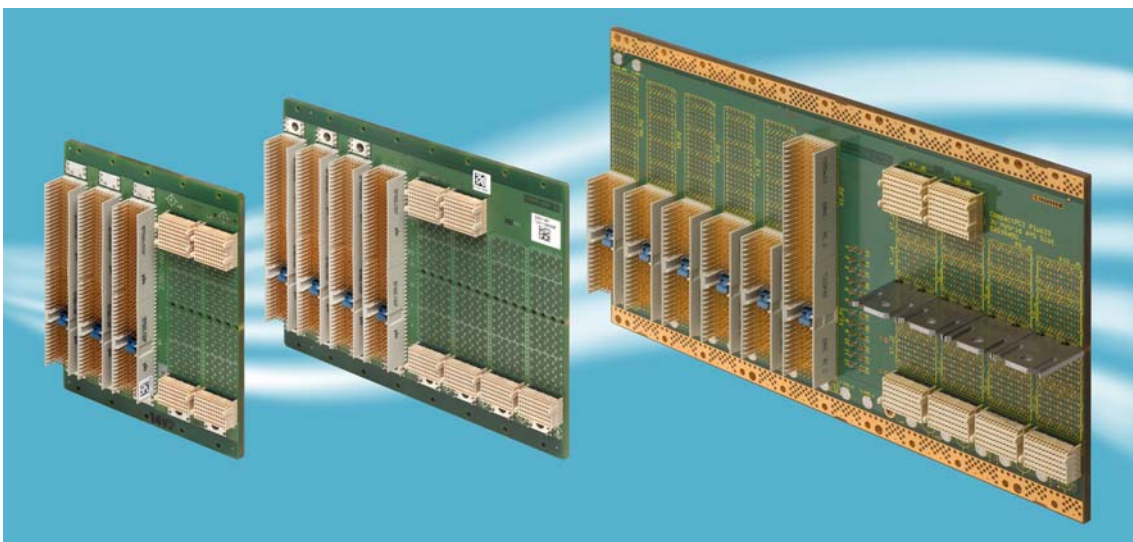

Sample Hybrid CompactPCI® & CompactPCI® Serial Backplanes



CompactPCI® PlusIO Rack



Small CompactPCI® PlusIO Box

Installing and Replacing Components

Before You Begin

Warnings

The procedures in this chapter assume familiarity with the general terminology associated with industrial electronics and with safety practices and regulatory compliance required for using and modifying electronic equipment. Disconnect the system from its power source and from any telecommunication links, networks or modems before performing any of the procedures described in this chapter. Failure to disconnect power, or telecommunication links before you open the system or perform any procedures can result in personal injury or equipment damage. Some parts of the system can continue to operate even though the power switch is in its off state.



Caution

Electrostatic discharge (ESD) can damage components. Perform the procedures described in this chapter only at an ESD workstation. If such a station is not available, you can provide some ESD protection by wearing an antistatic wrist strap and attaching it to a metal part of the system chassis or board front panel. Store the board only in its original ESD protected packaging. Retain the original packaging (antistatic bag and antistatic box) in case of returning the board to EKF for repair.



Installing the Board

Warning

This procedure should be done only by qualified technical personnel. Disconnect the system from its power source before doing the procedures described here. Failure to disconnect power, or telecommunication links before you open the system or perform any procedures can result in personal injury or equipment damage.

Typically you will perform the following steps:

- Switch off the system, remove the AC power cord
- Attach your antistatic wrist strap to a metallic part of the system
- Remove the board packaging, be sure to touch the board only at the front panel
- Identify the related CompactPCI® slot (peripheral slot for I/O boards, system slot for CPU boards, with the system slot typically most right or most left to the backplane)
- Insert card carefully (be sure not to damage components mounted on the bottom side of the board by scratching neighbored front panels)
- A card with onboard connectors requires attachment of associated cabling now
- Lock the ejector lever, fix screws at the front panel (top/bottom)
- Retain original packaging in case of return



Removing the Board

Warning

This procedure should be done only by qualified technical personnel. Disconnect the system from its power source before doing the procedures described here. Failure to disconnect power, or telecommunication links before you open the system or perform any procedures can result in personal injury or equipment damage.

Typically you will perform the following steps:

- Switch off the system, remove the AC power cord
- Attach your antistatic wrist strap to a metallic part of the system
- Identify the board, be sure to touch the board only at the front panel
- Unfasten both front panel screws (top/bottom), unlock the ejector lever
- Remove any onboard cabling assembly
- Activate the ejector lever
- Remove the card carefully (be sure not to damage components mounted on the bottom side of the board by scratching neighbored front panels)
- Store board in the original packaging, do not touch any components, hold the board at the front panel only



Warning

Do not expose the card to fire. Battery cells and other components could explode and cause personal injury.



EMC Recommendations



In order to comply with the CE regulations for EMC, it is mandatory to observe the following rules:

- The chassis or rack including other boards in use must comply entirely with CE
- Close all board slots not in use with a blind front panel
- Front panels must be fastened by built-in screws
- Cover any unused front panel mounted connector with a shielding cap
- External communications cable assemblies must be shielded (shield connected only at one end of the cable)
- Use ferrite beads for cabling wherever appropriate
- Some connectors may require additional isolating parts

Recommended Accessories

Blind CPCI Front Panels	EKF Elektronik	Widths currently available (1HP=5.08mm): with handle 4HP/8HP without handle 2HP/4HP/8HP/10HP/12HP
-------------------------	----------------	--

Replacement of the Battery

When your system is turned off, a battery maintains the voltage to run the time-of-day clock and to keep the values in the CMOS RAM.

Most versions of PC6-TANGO are delivered with a battery holder which allows easy replacement of the coin cell. Be sure to use a BR2032 cell as spare part to ensure an extended temperature range. Be careful when removing the old cell and inserting the new one.

For boards with a soldered battery the used battery must be desoldered, and the new one soldered. For this case, we recommend strongly that you return the board to EKF for battery replacement.

Warning

Danger of explosion if the battery is incorrectly replaced or shorted. Replace only with the same or equivalent type. Do not expose a battery to fire.



Technical Reference

Local PCI Devices

The following table shows the on-board PCI devices and their location within the PCI configuration space. Most devices are part of the APL-I SoC.

Bus #	Device #	Function #	Vendor ID	Device ID	Description
0	0	0	0x8086	0x5AF0	APL SoC Host Bridge
0	2	0	0x8086	0x5A84	APL SoC Integrated Graphics Device
0	3	0	0x8086	0x5A88	APL SoC Imaging Unit
0	14	0	0x8086	0x5A98	APL SoC Audio
0	18	0	0x8086	0x5AE0	APL SoC SATA
0	19	0	0x8086	0x5AD8	APL SoC PCIe-A Port #0
0	19	1	0x8086	0x5AD9	APL SoC PCIe-A Port #1
0	19	2	0x8086	0x5ADA	APL SoC PCIe-A Port #2
0	19	3	0x8086	0x5ADB	APL SoC PCIe-A Port #3
0	20	0	0x8086	0x5AD6	APL SoC PCIe-B Port #0
0	20	1	0x8086	0x5AD7	APL SoC PCIe-B Port #1
0	21	0	0x8086	0x5AA8	APL SoC USB xHCI Controller
0	22	0	0x8086	0x5AAC	APL SoC I2C Interface #0
0	22	1	0x8086	0x5AAE	APL SoC I2C Interface #1
0	24	0	0x8086	0x5ABC	APL SoC UART Interface #0
0	27	0	0x8086	0x5ACA	APL SoC SDXC Host Controller
0	28	0	0x8086	0x5ACC	APL SoC eMMC Controller
0	31	0	0x8086	0x5AE8	APL SoC LPC Bridge
0	31	1	0x8086	0x5AD4	APL SoC SMBus Controller
1 ¹⁾	0	0	0x12D8	0x2608	PCIe Switch Root Port (PI7C9X2G606)
2 ¹⁾	1,2,4 ...	0	0x12D8	0x2608	PCIe Switch Downstream Ports (PI7C9X2G606)
3 ¹⁾	0	0	0x8086	0x1533	Ethernet Controller NC2 (i210IT)
4 ¹⁾	0	0	0x8086	0x1533	Ethernet Controller NC1 (i210IT)
5 ¹⁾	0	0	0x8086	0x1533	Ethernet Controller NC4 (i210IT)
6 ¹⁾	0	0	0x8086	0x1533	Ethernet Controller NC3 (i210IT)
7 ¹⁾	0	0	0x1B4B	0x9170	SATA Host Controller (88SE9170)

¹⁾ Bus number may vary depending on devices situated on the backplane and the PCI enumeration schema implemented in UEFI/BIOS.

Local SMB/I²C Devices

The PC6-TANGO contains devices that are attached to the APL-I SoC System Management Bus (SMBus). These are the SPD EEPROM for the on-board memory, the PLD (MachXO2) glue logic including a set of board control and status registers, the CPU PMIC, a PCIe clock buffer, a general purpose serial EEPROM and two general purpose, non-volatile electronic jumpers.

Additional off-board devices may be addressed via discrete I2C master controllers provided by the APL-I SoC. While the APL I2C port 0 is used on the mezzanine connector P-EXP, the APL I2C port 1 is wired to the CompactPCI® backplane connector J1 for peripheral card usage. The separation in different threads reduces considerably potential SMBus/I2C addressing conflicts.

Controller	Address	Description
SMBus	0x2E	Board Control/Status (MachXO FPGA)
SMBus	0x2F	Non-volatile Electronic Jumper
SMBus	0x50	SPD on-Board Memory
SMBus	0x57	Board ID EEPROM
SMBus	0x5E	PMIC
SMBus	0x6B	DB800 Clock Buffer
I2C[0]	¹⁾	P-EXP (Pins 29/30)
I2C[1]	¹⁾	CPCI Backplane Connector J1 (Pins B17/C17)

¹⁾ Address depends on devices attached

Board Control and Status Registers (BCSR)

A set of board control and status registers allow to program special features on the PC6-TANGO:

- ▶ Assert a full reset
- ▶ Control activity of front panel reset and power event button
- ▶ Program time-outs and trigger a watchdog
- ▶ Get access to two LEDs in the front panel
- ▶ Get power fail and watchdog status of last board reset

The register set consists of five registers located on the SMBus at Device ID=0x5c on the following addresses:

- ▶ 0xA0: CMD_CTRL0_WR: Write to Control Register 0 (Write-Only)
- ▶ 0xA1: CMD_CTRL0_RD: Read from Control Register 0 (Read-Only)
- ▶ 0xB0: CMD_STAT0_WR: Write to Status Register 0 (Write-Clear)
- ▶ 0xB1: CMD_STAT0_RD: Read from Status Register 0 (Read-Only)
- ▶ 0xB2: CMD_STAT1_WR: Write to Status Register 1 (Write-Clear)
- ▶ 0xB3: CMD_STAT1_RD: Read from Status Register 1 (Read-Only)
- ▶ 0xC1: CMD_PLDREV_RD: Read from PLD Revision Register (Read-Only)

To prevent malfunction accesses to the registers should be done by SMBus "Byte Data" commands. Further writes to read-only or reads to write-only registers should be omitted.

Write/Read Control Register 0

Write: SMBus Address 0xA0

Default after reset: 0x00

Read: SMBus Address 0xA1

Bit	Description CMD_CTRL0
7	GPLED 0=Green part of the front panel LED GP is off (Default) 1=Green part of the front panel LED GP is on
6	FPDIS 0=Enable the front panel handle switch (Default) 1=Disable the front panel handle switch
5	FERP# 0=The front panel handle switch generates a power event (Default) 1=The front panel handle switch generates a system reset
4:3	WDGT0:WDGT1 Maximum Watchdog retrigger time: 0:0 2 sec 1:0 10 sec 0:1 50 sec 1:1 250 sec
2	WDGTRG Retrigger Watchdog. Any change of this bit will retrigger the watchdog. After a system reset the watchdog is in an inactive state. The watchdog is armed on the 1 st edge of this bit.
1	PGLED 0=Red part of the front panel LED PG is off (Default) 1=Red part of the front panel LED PG is blinking
0	SRES 0=Normal operation (Default) 1=A system reset is performed

Read/Clear Status Register 0

Write: SMBus Address 0xB0

Read: SMBus Address 0xB1

Bit	Description CMD_STAT0
7	PF18S 0=Normal operation 1=Last system reset may be caused by a power failure of the +V1.8S voltage regulator
6	RESERVED Always read as 0
5	RESERVED Always read as 0
4	PF135S 0=Normal operation 1=Last system reset may be caused by a power failure of the +V1.35S4 voltage regulator
3	RESERVED Always read as 0
2	RESERVED Always read as 0
1	RESERVED Always read as 0
0	RESERVED Always read as 0

The bits in this register are sticky, i.e. their state will be kept even if a system reset occurs. To clear the bits a write to the register with arbitrary data may be performed.

Read/Clear Status Register 1

Write: SMBus Address 0xB2

Read: SMBus Address 0xB3

Bit	Description CMD_STAT1
7	WDGARM 0=Normal operation 1=The watchdog is armed and has to be retriggered within its time-out period
6	WDGRST 0=Normal operation 1=Last system reset may be caused by a watchdog time-out
5	WDGHT 0=Normal operation 1=The watchdog already has elapsed half of its time-out period
4	PF12A 0=Normal operation 1=The +V12A voltage rail is not present in the system
3	PF5S 0=Normal operation 1=Last system reset may be caused by a power failure of the +V5S voltage regulator
2	RESERVED Always read as 0
1	RESERVED Always read as 0
0	PF33S 0=Normal operation 1=Last system reset may be caused by a power failure of the +V3.3S voltage regulator

Except of WDGHT and WDGARM the bits in this register are sticky, i.e. their state will be kept even if a system reset occurs. To clear the bits a write to the register with arbitrary data may be performed.

Read PLD Revision Register

Write: Not allowed

Read: SMBus Address 0xC1

Bit	Description CMD_PLDREV
7:0	PLDREV Read PLD Revision Number

GPIO Usage

GPIO Usage APL-I SoC

GPIO Usage APL-I SoC			
GPIO	Type	Function	Description
0-15	I	N/A	Not connected on PC6
16	O	GP_LED_RED	General Purpose Red LED Control (via PLD)
17	I	CPCI_FAL	CompactPCI Power Failure Line CPCI_FAL# via inverting level shifter
18	O	CPCI_INTS_EN	LOW: Isolate SERIRQ from CPCI_INTS HIGH: Connect SERIRQ to CPCI_INTS
19	O	SE_SYS_WP	General Purpose Serial EEPROM Write Protection
20	O	TPM_PP	TPM2.0 Physical Present Pin
21	O	ENABLE_NC3	Enable Ethernet Controller NC3
22	O	ENABLE_NC4	Enable Ethernet Controller NC4
23	O	ENABLE_NC1	Enable Ethernet Controller NC1
24	O	ENABLE_NC2	Enable Ethernet Controller NC2
25	I	GP_JUMP#	Reset UEFI/BIOS Setup to Factory Defaults, Jumper J-GP
26	O	SATA_SOC_ACT#	Native: Signal APL SATA activity via green HD LED in Front Panel (via PLD)
27	O	PPSM_EN	Connect IEEE 1588 PPS/PPM to J-GP and CompactPCI® J2 LOW: PPS/PPM disconnected from J-GP and J2 HIGH: PPS/PPM connected to J-GP and J2
28-31	I	BOARD_CFG	Board Configuration Jumpers BOARD_CGF[0:3]
32	O	USB_FP1_PEN	USB Front Panel Right Port Power Enable
33	O	USB_FP2_PEN	USB Front Panel Left Port Power Enable
183	I	EXP_SMI#	Expansion Interface SMI Request (from P-EXP Pin 15 via level shifter)
ISH 0	O	SOC_HDA_BCLK	Native: HD Audio BCLK (to P-EXP Pin 37 via level shifter)
ISH 1	O	SOC_HDA_SYNC	Native: HD Audio SYNC (to P-EXP Pin 36 via level shifter)
ISH 2	I	SOC_HDA_SDI	Native: HD Audio IN (from P-EXP Pin 34 via level shifter)
ISH 3	O	SOC_HDA_SDO	Native: HD Audio OUT (to P-EXP Pin 33 via level shifter)
ISH 4-6	I	HW_REV	PCB Revision Code HW_REV[2:0]: GPIO[6:4] 000 001 010 ... 111 Revision 0 1 2 ... 7
ISH 7	I	CPCI_ENUM#	CompactPCI System Enumeration Line ENUM# (from J1 Pin C25 via level shifter)
ISH 8	I	CPCI_INTP	CompactPCI Interrupt Request Line CPCI_INTP (from J1 Pin E4 via level shifter)

GPIO Usage APL-I SoC			
GPIO	Type	Function	Description
ISH 9	O	SPEAKER	Native: Speaker output (to P-EXP Pin 39 via MOSFET)

J-GP UEFI/BIOS Defaults & IEEE 1588 Pulse per Second

The jumper J-GP may be used to reset the UEFI/BIOS configuration settings to a default state. The UEFI/BIOS on PC6-TANGO stores most of its settings in an area within the UEFI/BIOS flash, e.g. the actual boot devices. Using the jumper J-GP is only necessary, if it is not possible to enter the setup of the UEFI/BIOS. To reset the settings mount a jumper on J-GP and perform a system reset. As long as the jumper is stuffed the UEFI/BIOS will use the default configuration values after any system reset. To get normal operation again, the jumper has to be removed.

There is also an alternate function available on J-GP. Pin 1 of this jumper carries a TTL level Pulse per Second (PPS) signal according the IEEE 1588 specification when enabled by UEFI/BIOS settings. A wire may be connected to trigger events on external devices.

NOTE: The PPS TTL level signal is also available via the CompactPCI® PlusIO connector J2 pin D14 (SATA-SCL), for rear I/O usage (must be enabled by GPIO27 of the APL-I SoC).



J-GP	Function
Jumper Removed ¹⁾	Normal operation
Jumper Installed	UEFI/BIOS configuration reset performed

¹⁾ This setting is the factory default

Manufacturer Mode Jumper (J-MFG)

The jumper J-MFG is used to bring the board into the manufacturer mode. This is necessary only on board production time and should not be used by customers. For normal operation the jumper should be removed. The pin header J-MFG is not stuffed on the PC6-TANGO by default.



J-MFG	Function
Jumper Removed ¹⁾	Normal operation
Jumper Installed	Entering Manufacturer Mode

¹⁾ This setting is the factory default

RTC Reset (J-RTC)

The jumper J-RTC may be used to reset certain register bits of the battery backed RTC core within the APL-I SoC. This can be necessary under rare conditions (e.g. battery undervoltage), if the CPU fails to enter the UEFI/BIOS POST after power on. Note that installing of jumper J-RTC will neither set UEFI/BIOS Setup to EKF Factory Defaults nor resets the time and date register values of the RTC (Real Time Clock). To reset the RTC core the board must be removed from the system rack. Short-circuit the pins of J-RTC for about 1 sec. Thereafter reinstall the board to the system and switch on the power. It is important to accomplish the RTC reset while the board has no power. The pin header J-RTC is not stuffed on the PC6-TANGO by default.



J-RTC

J-RTC	Function
Jumper Removed ¹⁾	Normal operation
Jumper Installed	RTC reset performed

¹⁾ This setting is the factory default.

Connectors

Caution

Some of the internal connectors provide operating voltage (3.3V, 5V and 12V) to devices inside the system chassis, such as internal peripherals. Not all of these connectors are short circuit protected. Do not use these internal connectors for powering devices external to the computer chassis. A fault in the load presented by the external devices could cause damage to the board, the interconnecting cable and the external devices themselves.

Front Panel Connectors

The PC6-TANGO front panel is provided with dual receptacles for monitors (DisplayPort), USB devices (Type-A 5Gbps), and networking (RJ45 GbE). In addition, a Micro SD card slot is available.

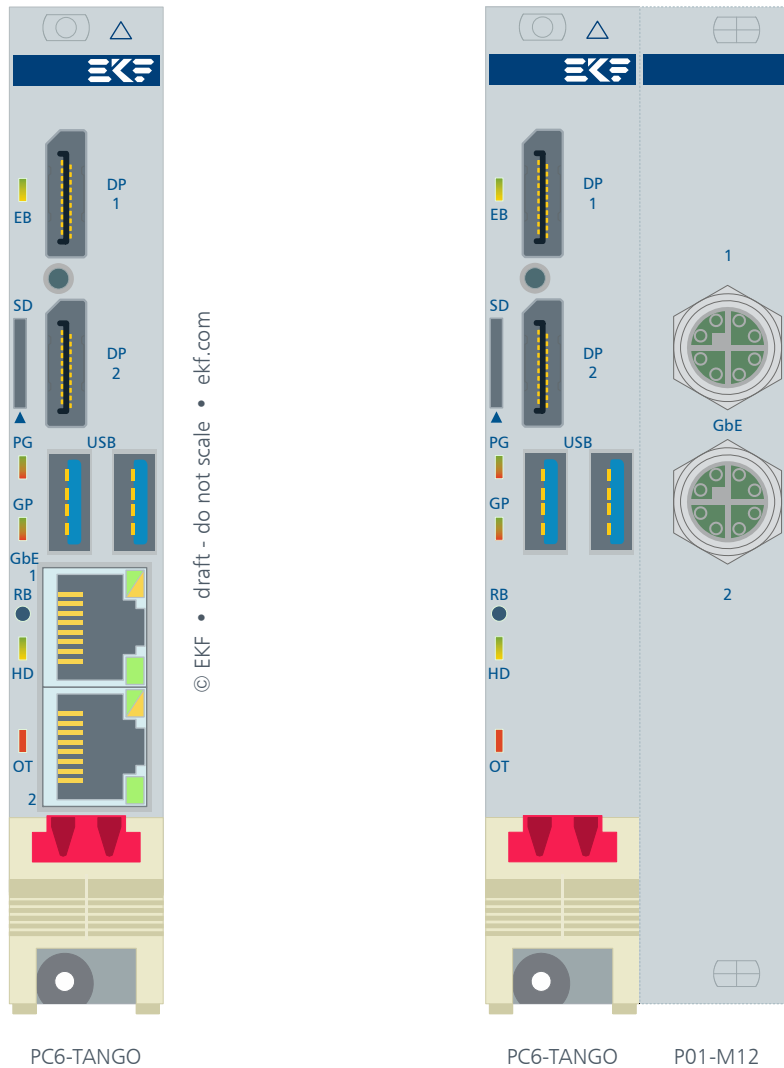

As an ordering option, the RJ45 jacks can be replaced by M12 Xcoded receptacles, which requires an 8HP front panel assembly in combination with a small mezzanine module P01-M12.

DisplayPort Connectors

The Intel® Core™ processors used on PC6-TANGO are equipped with an integrated graphics controller, which supports DisplayPort interfaces permitting simultaneous independent operation of multiple displays. Two DP receptacles are available from the PC6-TANGO front panel.

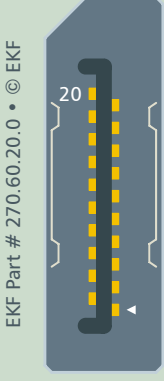
DisplayPort P-DP1/2				
	20	PWR ¹⁾	19	RETURN (GND)
	18	HPD	17	AUX_CH(N)
	16	GND	15	AUX_CH(P)
	14	CONFIG2 (GND)	13	CONFIG1
	12	LANE3(N)	11	GND
	10	LANE3(P)	9	LANE2(N)
	8	GND	7	LANE2(P)
	6	LANE1(N)	5	GND
	4	LANE1(P)	3	LANE0(N)
	2	GND	1	LANE0(P)

¹⁾ +3.3V via current-limited electronic power switch. This voltage is switched on in S0 state only.

Most professional monitors are equipped with a DisplayPort connector input. For attachment of either VGA, DVI or HDMI type display to the PC6-TANGO, there are suitable adapters and also adapter cables available.

For rugged applications, DisplayPort cable assemblies with a connector latching mechanism are recommended.

USB Connectors

The Intel® APL-I SoC incorporates an USB 3.0 xHCI host controller (USB 3.1 Gen1 SuperSpeed 5Gbps). Two ports are directly available on the PC6-TANGO front panel (type A receptacle), for attachment of external USB devices.

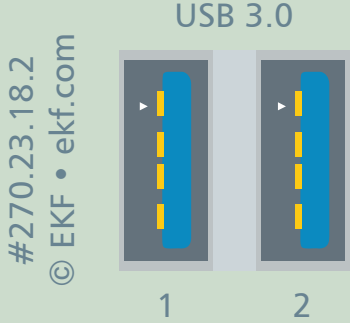
P-USB • Dual USB 3.0 Receptacle		
USB 3.0 dual Type-A receptacle, stacked, 18-position		
	1	VBUS +5V, 1.5A max ¹⁾
	2	USB D-
	3	USB D+
	4	GND
	5	SS RX-
	6	SS RX+
	7	GND
	8	SS TX-
	9	SS TX+

¹⁾ +5V via 1.5A current-limited electronic power switch. Power rail may be switched off by software independently for each port.

For rugged applications EKF offers custom specific USB cable connector retainer solutions (similar picture below).

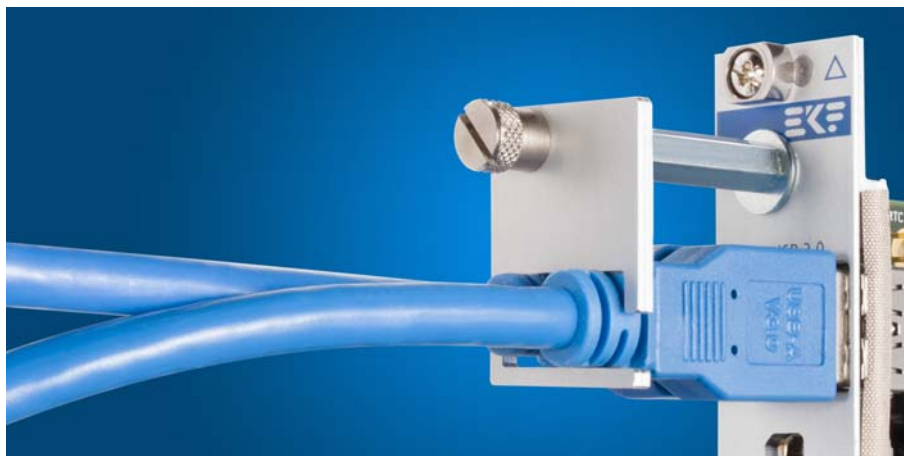

Ethernet Connectors RJ45

All Ethernet ports on the PC6-TANGO are based on individual I210IT PCIe to Ethernet controllers, i.e. offer different MAC addresses, hence suitable for simple network attachment or flexible usage as router or gateway. The IEEE 1588 PPS signal (refer to backplane connector J2) is derived from the NIC1 which is wired to the upper RJ45 connector (Port 1).

Gigabit Ethernet Ports 1/2 (P-ETH, RJ-45)				
 <p>270.02.08.5</p>	Port 1	IEEE 1588 PPS	1	NC1_MDX0+
			2	NC1_MDX0-
			3	NC1_MDX1+
			4	NC1_MDX2+
			5	NC1_MDX2-
			6	NC1_MDX1-
			7	NC1_MDX3+
			8	NC1_MDX3-
	Port 2	1	NC2_MDX0+	
		2	NC2_MDX0-	
		3	NC2_MDX1+	
		4	NC2_MDX2+	
		5	NC2_MDX2-	
		6	NC2_MDX1-	
		7	NC2_MDX3+	
		8	NC2_MDX3-	

The lower green LED of each front panel connector indicates LINK established when continuously on, and data transfer (activity) when blinking. If the lower green LED is permanently off, no LINK is established. The upper green/yellow dual-LED signals the link speed 1Gbit/s when lit yellow, 100Mbit/s when lit green, and 10Mbit/s when off.

Option M12 X-Coded Ethernet Receptacles

As an ordering option, the RJ45 jacks can be replaced by M12 X-coded receptacles. A small mezzanine module (P01-M12) is soldered to the RJ45 footprint, resulting in an 8HP front panel assembly.

M12 X-Coded Front Panel I/O Receptacles			
Gigabit Ethernet • 271.12.008.20 • M12-X Flush-type socket			
	Ports 1-2	1	MDX0+
		2	MDX0-
		3	MDX1+
		4	MDX1-
		5	MDX3+
		6	MDX3-
		7	MDX2-
		8	MDX2+

The pin numbers of an M12 X-coded connector do not reflect the RJ45 Gigabit Ethernet signal assignment. For cross-over patch cables M12 to RJ45 please refer to the table below.

M12 X	Signal Colors T568B	RJ45
1	MDX0+ white/orange	1
2	MDX0- orange	2
3	MDX1+ white/green	3
4	MDX1- green	6
5	MDX3+ white/brown	7
6	MDX3- brown	8
7	MDX2- white/blue	5
8	MDX2+ blue	4

Suitable industrial Gigabit Ethernet M12 cable assemblies can be ordered from EKF, or directly from well-known cable and connector manufacturers e.g. Metz, Phoenix, Escha and many others.

Ordering Information Cable Assemblies
Gigabit Ethernet cable M12 to M12: #271.14.008.xx (xx=length/meter)
Gigabit Ethernet cable M12 to RJ-45: #271.15.008.xx (xx=length/meter)

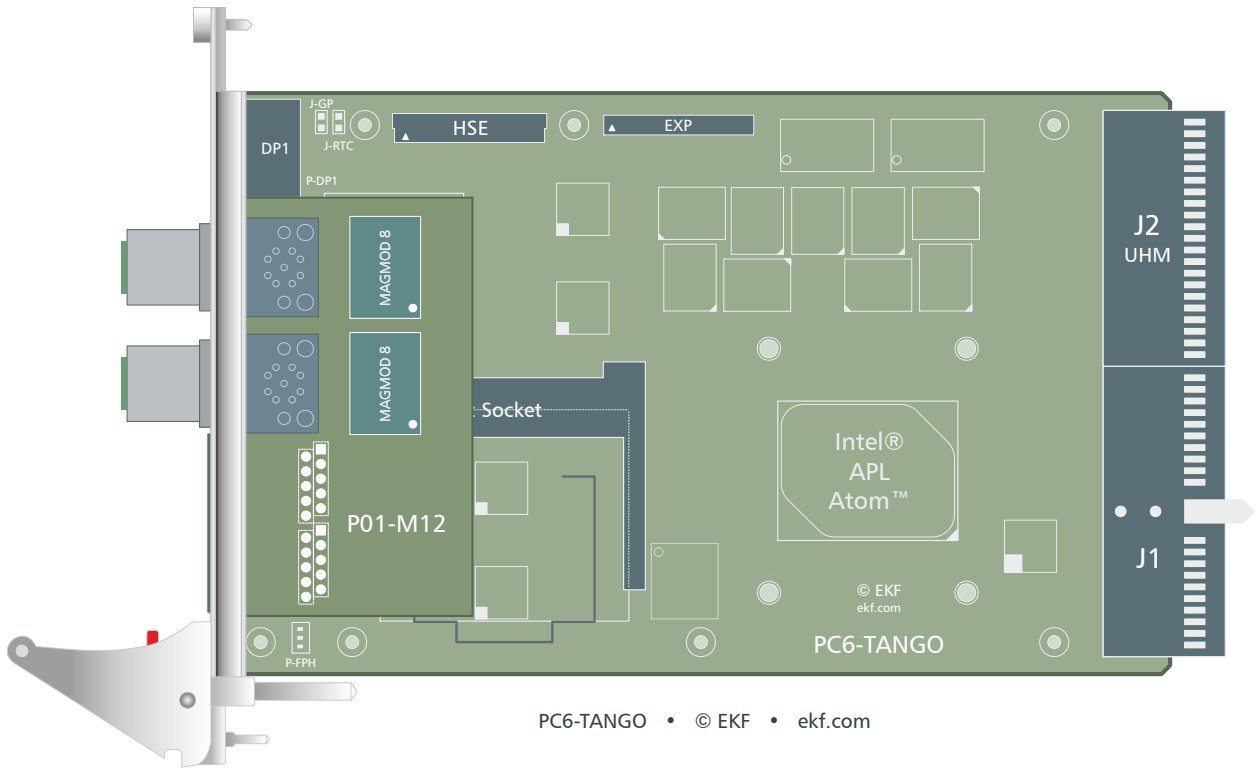

PC6-TANGO • © EKF • ekf.com

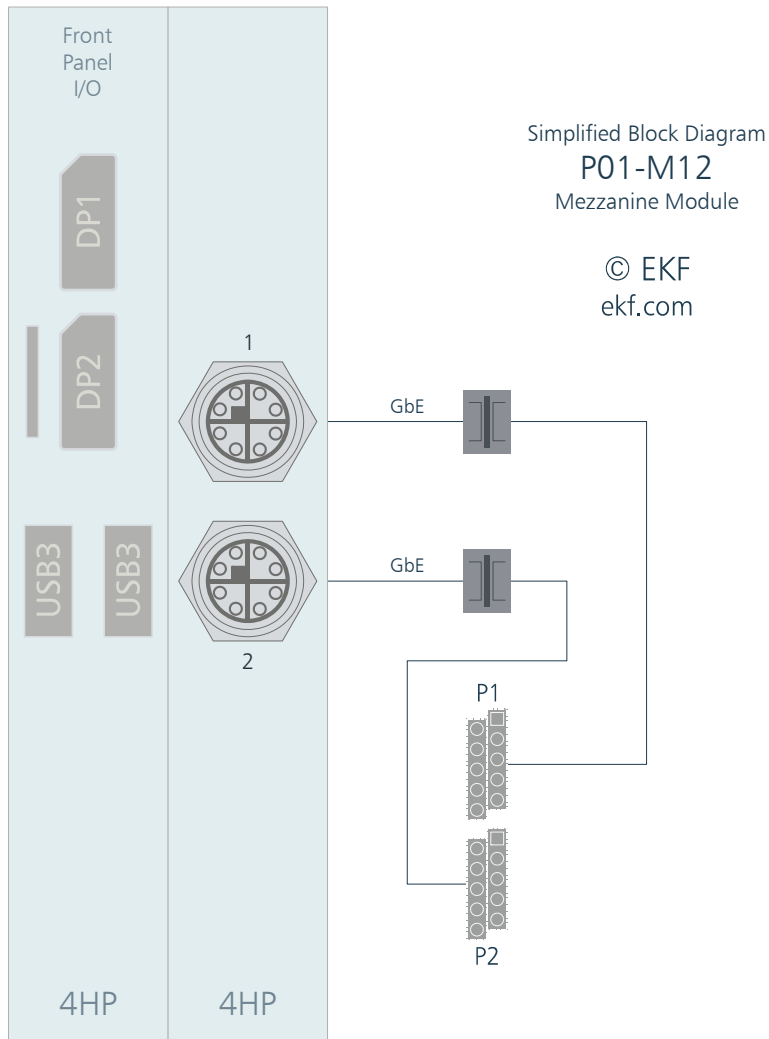

microSD Card Holder

The PC6-TANGO is provided with a front panel microSD card slot (push-push type, w. card detect switch).

microSDHC Host Connector • 218.6.010.1	
1	DAT2
2	DAT3
3	CMD
4	+3.3V
5	CLK
6	GND
7	DAT0
8	DAT1

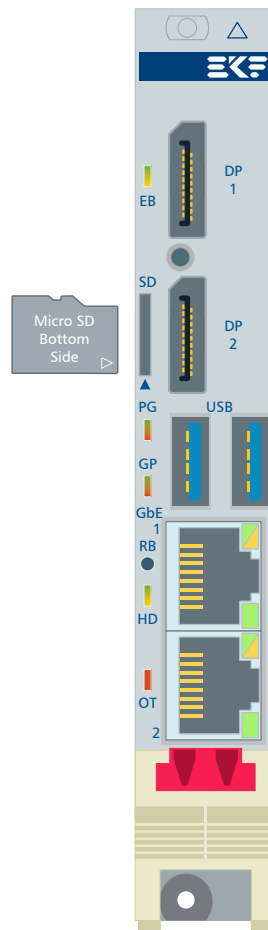

© EKF • draft - do not scale • ekf.com

PC6-TANGO

CFast™ Card Holder

By default, the PC6-TANGO is provided with a CFast™ host connector. It is suitable for CFast™ cards, which have the same dimensions as CompactFlash™ cards, but are operated in SATA mode. Industrial CFast™ SSD cards are available up to 256GB as of current. The SATA channel available on the CFast™ socket is derived directly from the APL-I SoC (SATA port 0). Since SATA based SSD modules are fast and reliable over the industrial temperature range, a CFast™ card can be used as boot device in many applications.

A guiding rail is provided to simplify card insertion. Once installed, the CFast™ card will have to be locked. This can be done either by a retainer latch, in order to withstand shock and vibration. The latching part may be supplied loosely (not assembled on the PC6-TANGO, depending on your order), and hence must be snapped onto the CFast™ socket first, before being used (similar picture below).

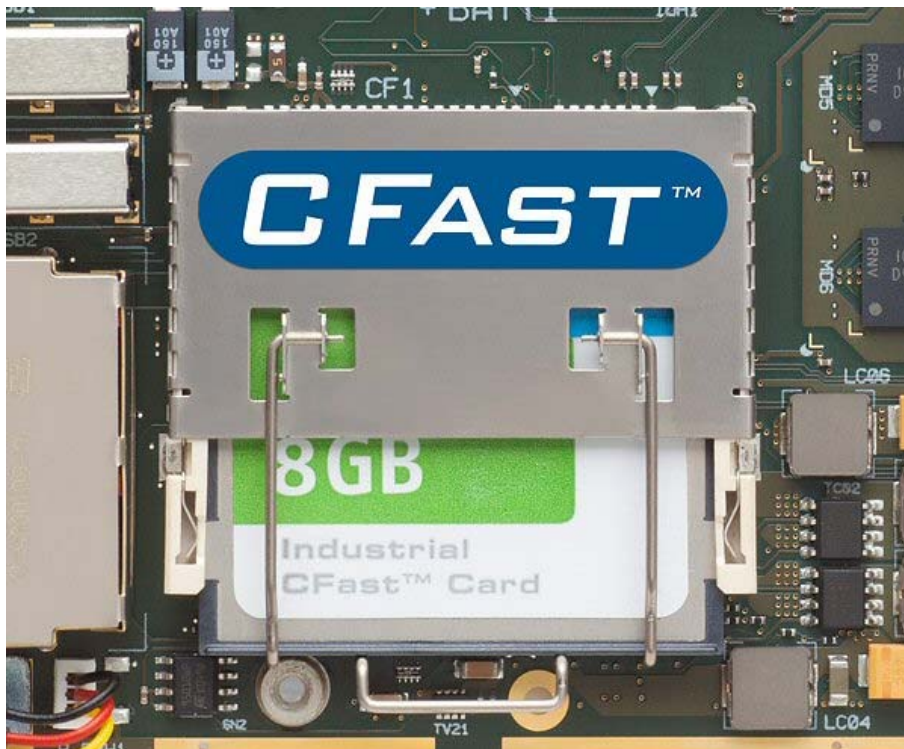

CFast™ Socket w. Card Retainer Clip

As an alternate, when the PC6-TANGO is combined with a low profile mezzanine module such as the C48-M2, the latching retainer will be replaced by a small mounting block, fixed by a screw on the PCB bottom side.

If the CFast™ host connector is not in use in an application, please remove the latching retainer assembly carefully from the socket (strut the snap-in clips on both sides). As an alternate, use an adhesive tape to fix the CFast™ retaining lever in its normal (locking) position. Otherwise, under worst conditions, the latching spring could cause a short circuit situation when unintentionally moving (forced by shock or vibration) and touching a PCB in the neighbored board slot of the system rack.

The fixation alternate of the CFast™ card is a small L-shape mounting block (similar picture below). The threaded mounting element is fastened by a metric screw (M2x4) from the bottom side of the PCB.



CFast™ Card Fixation w. Mounting Block

There is some ambiguity about the top and bottom side of a CFast™ module - be sure to insert the card properly into the socket. For several CFast™ SSD card brands this would require the module to be inserted with its label facing downwards (to the PCB). However, leading suppliers (e.g. Swissbit) attach the label vice versa on their cards, which requires that such CFast™ modules have to be inserted with their label on top. Anyway, the finger grip, which is recessed into the cards end, should be up. Forced wrong insertion may cause permanent damage to the CFast™ card and the CFast™ host connector.

CFast™ Card Locking Alternates

Retainer lever (can be actuated by hand w/o tool)	EKF part no. 218.5.024.29
Mounting block (screw driver required for fastening and release)	EKF part no. 710.9.CFA.B

P-CF CFast™ Host Connector • 218.5.024.21	
Part No. 218.5.024.21 • CFast™ Host Connector  © EKF • ekf.com	
S1	GND
S2	SATA_TXP (A+)
S3	SATA_TXN (A-)
S4	GND
S5	SATA_RXN (B-)
S6	SATA_RXP (B+)
S7	GND
PC1	CDI (GND)
PC2	GND
PC3	<i>DEVSLP</i>
PC4	<i>NC</i>
PC5	<i>NC</i>
PC6	<i>NC</i>
PC7	GND
PC8	<i>LED1</i>
PC9	<i>LED2</i>
PC10	<i>RSVD</i>
PC11	<i>RSVD</i>
PC12	<i>IFDet</i>
PC13	+3.3V 1)
PC14	+3.3V 1)
PC15	GND
PC16	GND
PC17	CDO 2)

signals italic/grey: NC

- 1) Overcurrent protected by electronic power switch (1.5A)
- 2) Used to enable the electronic power switch when card is fully inserted

SATA Rx/Tx signal direction as seen by the SATA host controller (APL-I SoC P0)

Mezzanine Connectors

The PC6-TANGO is equipped with two connectors for optional mezzanine expansion. The connector P-HSE is used for SATA based mass storage, available as low profile module (4HP assembly), e.g. C48-M2 (dual M.2 SATA SSD). The legacy connector P-EXP is provided mainly for custom specific side card design (8HP assembly).

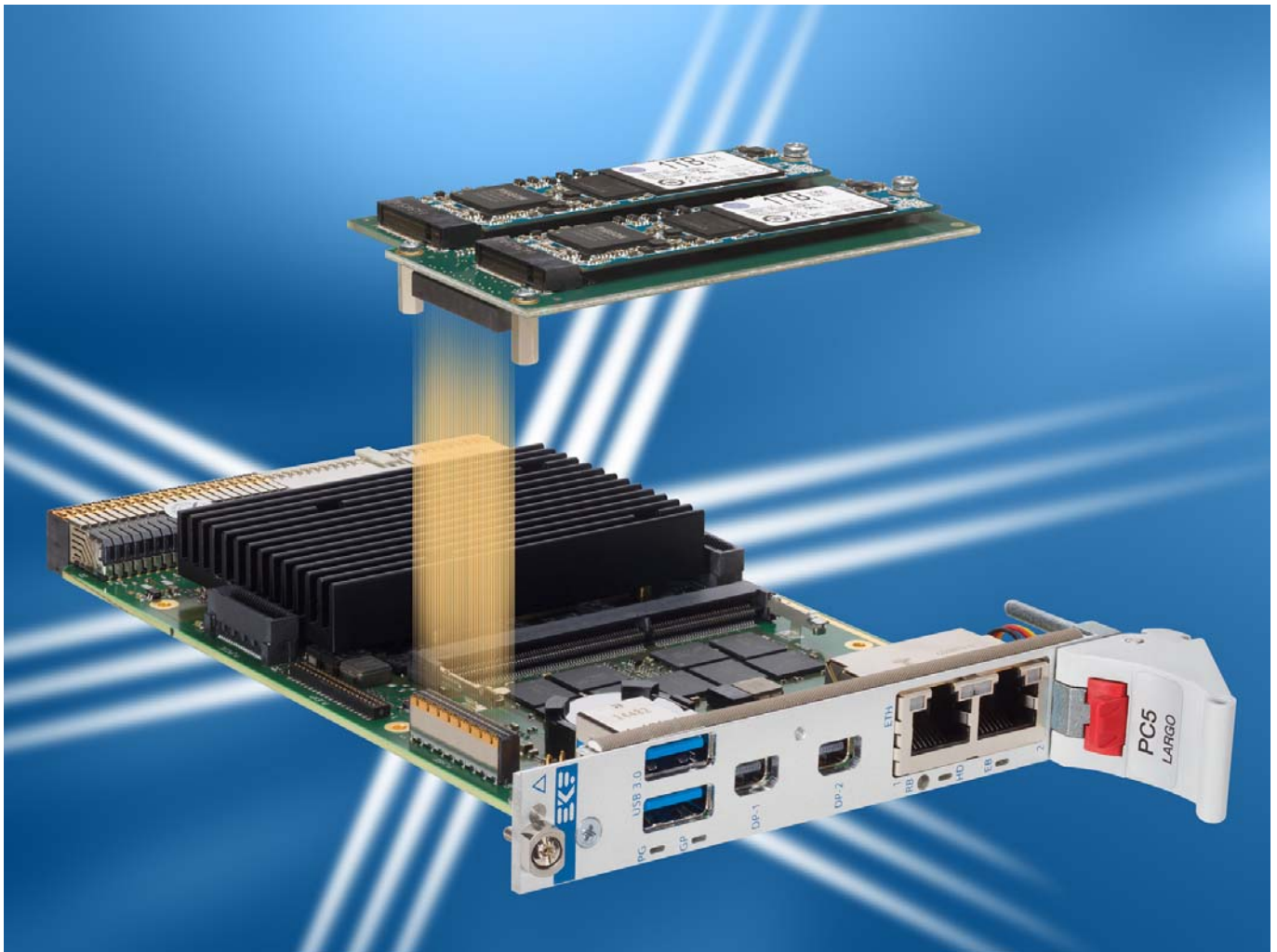

PC6-TANGO w. Low Profile Mezzanine Modul HSE Connector Based (Similar Picture)

WARNING: The +3.3V, +5V and +12V power pins of both mezzanine connectors P-EXP and P-HSE are not protected against a short circuit event. These connectors therefore should be used only for attachment of an approved expansion side card or low profile mezzanine module. The maximum current flow across these pins should be limited to 1A per power pin via P-HSE and 0.5A maximum across P-EXP pins.

Expansion Interface P-EXP

P-EXP				
	GND	1	2	+3.3V ¹⁾
	CLK (25MHz)	3	4	RST#
	LPC_AD0	5	6	LPC_AD1
	LPC_AD2	7	8	LPC_AD3
	LPC_FRAME#	9	10	NC
	GND	11	12	+3.3V ¹⁾
	LPC_SERIRQ	13	14	NC
	EXP_SMI#	15	16	SIO_CLK (14.3MHz)
	UART0_TXD ³⁾	17	18	UART0_RXD ³⁾
	NC	19	20	NC
	GND	21	22	+5V ¹⁾
	USB_EXP2-	23	24	USB_EXP1-
	USB_EXP2+	25	26	USB_EXP1+
	USB_EXP_OC#	27	28	EXP_RST#
	I2C_SCL ²⁾	29	30	I2C_SDA ²⁾
	GND	31	32	+5V ¹⁾
	HDA_SDOUT	33	34	HDA_SDIN
	HDA_RST#	35	36	HDA_SYNC
	HDA_CLK	37	38	NC
	SPEAKER	39	40	+12V ⁴⁾

- 1) Power rail switched on in state S0 only
- 2) Connected to APL-I SoC I2C port 0 (this I/F is separated from the local SMBus I/F)
- 3) TTL level signal, via level shifter to APL-I SoC
- 4) Only in systems which provide +12V via backplane (+/-12V are not necessary to operate PC6-TANGO)

High Speed Expansion Connector P-HSE

High Speed Expansion P-HSE				
<p>© EKF • 275.90.08.068.01 • ekf.com 1.00mm Pitch High Speed Female Connector (H=8mm)</p>	GND	a1	b1	GND
	SATA_HSE1_TXP ⁴⁾	a2	b2	NC
	SATA_HSE1_TXN ⁴⁾	a3	b3	NC
	GND	a4	b4	GND
	SATA_HSE1_RXN ⁴⁾	a5	b5	NC
	SATA_HSE1_RXP ⁴⁾	a6	b6	NC
	GND	a7	b7	GND
	SATA_HSE2_TXP ⁵⁾	a8	b8	NC
	SATA_HSE2_TXN ⁵⁾	a9	b9	NC
	GND	a10	b10	GND
	SATA_HSE2_RXN ⁵⁾	a11	b11	NC
	SATA_HSE2_RXP ⁵⁾	a12	b12	NC
	GND	a13	b13	GND
	NC	a14	b14	NC
	NC	a15	b15	NC
	GND	a16	b16	GND
	NC	a17	b17	NC
	NC	a18	b18	NC
	GND	a19	b19	GND
	NC	a20	b20	NC
	NC	a21	b21	NC
	+3.3VS ¹⁾	a22	b22	+5VS ¹⁾
	+3.3VS ¹⁾	a23	b23	+5VS ¹⁾
	+3.3VA ²⁾	a24	b24	+5VA ²⁾
	+12V ³⁾	a25	b25	+12V ³⁾

¹⁾ Power rail switched on in state S0 only (switched)

²⁾ Power rail on when system power supply is up

³⁾ Only in systems which provide +12V via backplane (+/-12V are not necessary to operate PC6-TANGO)

⁴⁾ SATA 1 channel derived from the APL-I SoC SATA controller

⁵⁾ SATA 2 channel derived from the optional 88SE9170 SATA controller

All TX/RX signal directions with respect to the SATA controller.



C47-MSATA Mezzanine Storage Module Based on the Connector HSE



C48-M2 Mezzanine Storage Module Based on the Connector HSE

Pin Headers & Debug

Front Panel Handle Microswitch Header P-FPH

The jumper P-FPH is used for attachment of an external SPDT switch. By default, P-FPH is connected across a short cable harness to a microswitch, which is integrated into the PC6-TANGO front panel handle (ejector lever). The switch performs a power button event (e.g. system shutdown) by short-circuiting the pins 1 and 3 of P-FPH when activated (hold unlock button of front panel handle depressed momentarily).

P-FPH		
# 276.02.003.11 © EKF • ekf.com 		
1	black	Microswitch Pole (Common), Wired to PLD
2	red	Microswitch Throw - F/P Handle Locked Position, not connected
3	yellow	Microswitch Throw - F/P Handle Unlocked Position, Wired to GND

PLD Programming Header P-PLD

The PC6-TANGO is provided with a powerful PLD (Programmable Logic Device) which replaces legacy glue logic. The programming header P-PLD is not stuffed (in use for manufacturing only). Its footprint is situated at the bottom side of the board.

P-PLD	
240.1.08.1 • © EKF • ekf.com	
	
▲	
1	+3.3V
2	TDO
3	TDI
4	NC
5	KEY
6	TMS
7	GND
8	TCK

Firmware Programming Header P-SPI

The PC6-TANGO firmware (UEFI/BIOS, Intel® TXE) is stored in a Serial Flash memory. Updates are normally done by software. For debug and manufacturing a pin header P-SPI is provided (not stuffed by default) at the bottom side of the board.

P-SPI	
240.1.08.SPI • © EKF • ekf.com	
1	+1.8V
2	SPI_SO
3	SPI_SI
4	PROG_EN#
5	SPI_CS#
6	KEY
7	GND
8	SPI_CK

Processor Debug Header P-MIPI

The PC6-TANGO can be equipped with a 60-position processor debug header for JTAG based hard- and software debugging (Samtec QSH series connector aka MIPI-60 specified by the MIPI Alliance Debug Working Group *). The connector is suitable to attach a debugger (emulator) e.g. Lauterbach. The header P-MIPI resides on the PCB bottom side, but is not stuffed by default.

P-MIPI Processor Debug Connector • 275.83.05.060.01			
1	VREF_DEBUG (1.8V)	TMS/TMSC	2
3	TCK	TDO/EXTA	4
5	TDI/EXTB	RESET#	6
7	RTCK/EXTC	TRST#_PD	8
9	TRST#/EXTD	EXTE/TRIGIN/PREQ#	10
11	EXTF/TRIGOUT/PRDY#	VREF_TRACE (1.8V)	12
13	TRC_CLK0	TRC_CLK1	14
15	TARGET PRESENCE DETECT	GND	16
17	GND TRC_DATA000	TRC_DATA100	18
19	TRC_DATA001	TRC_DATA101	20
21	TRC_DATA002	TRC_DATA102	22
23	TRC_DATA003	TRC_DATA103	24
25	TRC_DATA004	TRC_DATA104	26
27	TRC_DATA005	TRC_DATA105	28
29	TRC_DATA006	TRC_DATA106	30
31	TRC_DATA007	TRC_DATA107	32
33	TRC_DATA008	TRC_DATA108	34
35	TRC_DATA009	POD_BOOT_HALT# TRC_DATA109	36
37	TRC_DATA010	POD_HOOK TRC_DATA110	38
39	TRC_DATA011	POD_PWRBTN# TRC_DATA111	40
41	TRC_DATA012	TRC_DATA112	42
43	TRC_DATA013	TRC_DATA113	44
45	TRC_DATA014	TRC_DATA114	46
47	TRC_DATA015	TRC_DATA115	48
49	TRC_DATA016	TRC_DATA116	50
51	TRC_DATA017	TRC_DATA117	52
53	TRC_DATA018	TRC_DATA118	54
55	TRC_DATA019	TRC_DATA119	56
57	GND	GND	58
59	TRC_CLK3	TRC_CLK2	60

pins grey/italic are pulled to GND

* MIPI01 MIPI Alliance Recommendation for Debug and Trace Connectors, version 1.10.00

Power Terminal Block

This option is provided for professional system integrators only

For stand-alone applications, the J1 backplane connector can be replaced on request by a two-circuit terminal block, suitable for attachment (screw connection) of stranded wires up to 1 mm². The power supply must provide +5V according to the CompactPCI® specification (+5%/-3%, <50mVpp ripple).

The PC6-TANGO may or may not be equipped with the backplane connector J2 for stand-alone operation (option rear I/O module via J2). Note that in this configuration the platform reset signal is missing (located on J1 pin C5). Using an adapted programming of the PLD on PC6-TANGO could solve this problem. Please discuss your needs with sales@ekf.de before ordering.

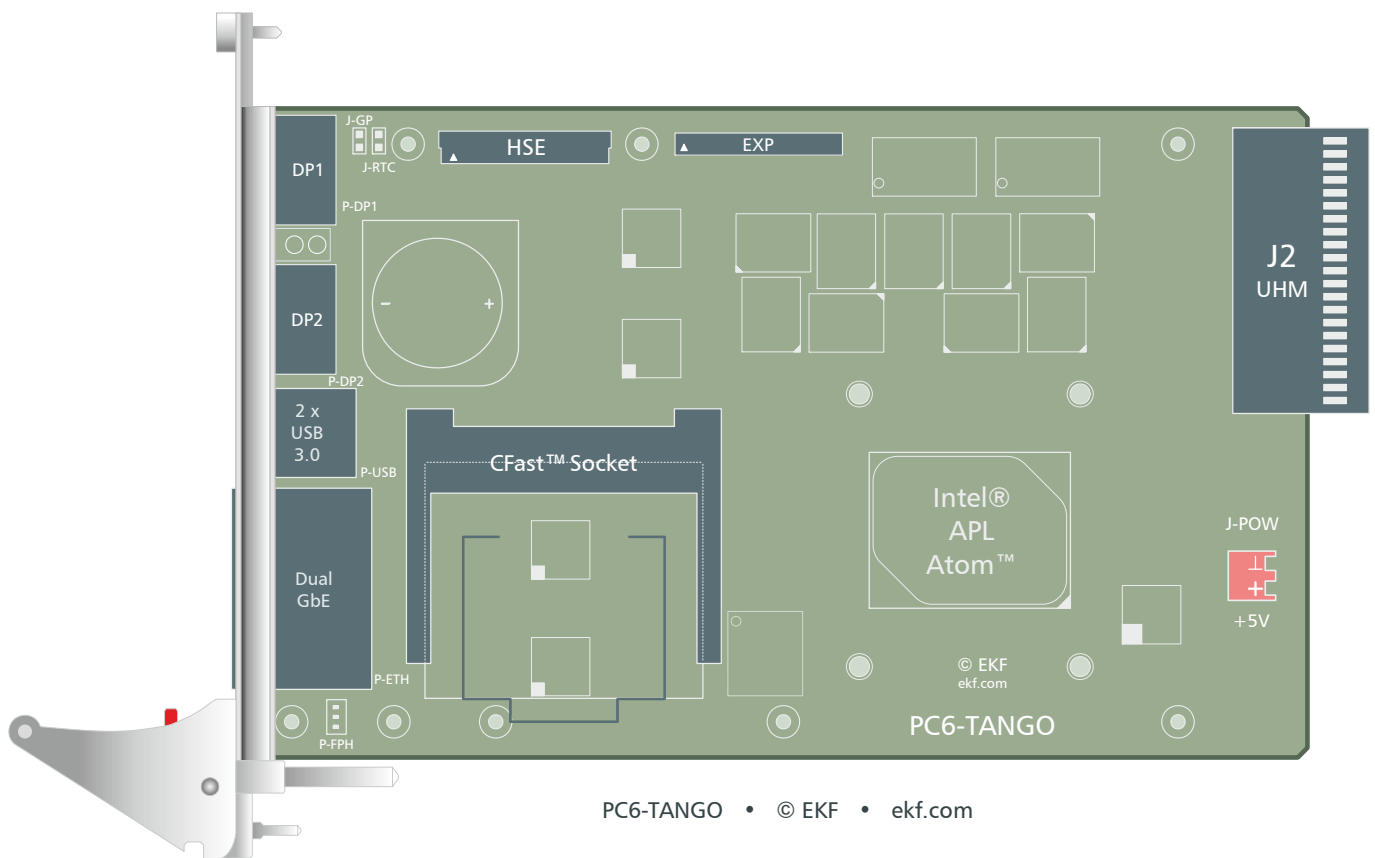

CAUTION: The PC6-TANGO is not equipped with a protection circuitry against inverted wires. A mistake will inevitably destroy the board caused by the interchanged polarity. Be extremely careful while installation.

Backplane Connectors

The backplane connector suite is comprised of two hard metric 2.0mm connectors. While the J1 connector is compliant to CompactPCI® PICMG® 2.0, the J2 connector pin assignment follows an enhancement specification named CompactPCI® PlusIO PICMG® 2.30. This allows to combine classic CompactPCI® peripheral cards (32bit PCI) and modern CompactPCI® Serial cards according to PICMG® CPCI-S.0 on a common hybrid backplane.

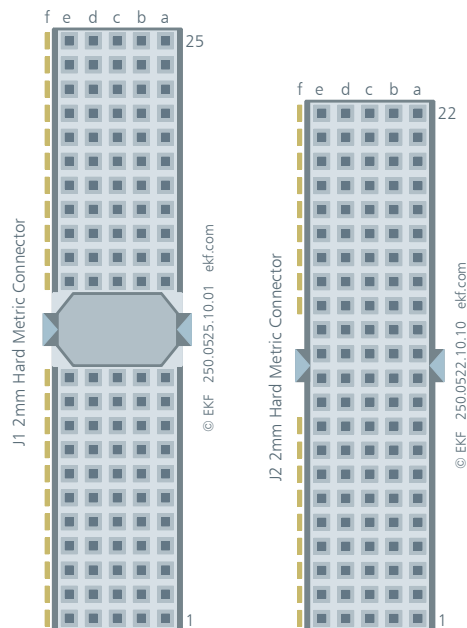

CompactPCI J1

J1	A	B	C	D	E
25	5V	REQ64# ²⁾	ENUM# ¹⁾	3.3V ⁹⁾	5V
24	AD1	5V	V(I/O)	AD0	ACK64# ²⁾
23	3.3V ⁹⁾	AD4	AD3	5V	AD2
22	AD7	GND	3.3V ⁹⁾	AD6	AD5
21	3.3V ⁹⁾	AD9	AD8	M66EN ⁷⁾	C/BE0#
20	AD12	GND	V(I/O)	AD11	AD10
19	3.3V ⁹⁾	AD15	AD14	GND	AD13
18	SERR# ¹⁾	GND	3.3V ⁹⁾	PAR	C/BE1#
17	3.3V ⁹⁾	IPMB SCL ³⁾	IPMB SDA ³⁾	GND	PERR# ¹⁾
16	DEVSEL# ¹⁾	GND	V(I/O)	STOP# ¹⁾	LOCK# ¹⁾
15	3.3V ⁹⁾	FRAME# ¹⁾	IRDY# ¹⁾	BD_SEL# ⁶⁾	TRDY# ¹⁾
14	KEY AREA (not keyed)				
13					
12					
11	AD18	AD17	AD16	GND	C/BE2#
10	AD21	GND	3.3V ⁹⁾	AD20	AD19
9	C/BE3#	<i>NC IDSEL</i>	AD23	GND	AD22
8	AD26	GND	V(I/O)	AD25	AD24
7	AD30	AD29	AD28	GND	AD27
6	REQ# ¹⁾	GND	3.3V ⁹⁾	CLK	AD31
5	<i>BRSVP1A5</i> ⁴⁾	<i>BRSVP1B5</i> ⁴⁾	RST#	GND	GNT#
4	IPMB PWR (+5V) ³⁾	GND <i>HEALTHY#</i>	V(I/O)	INTP ¹⁾	INTS ¹⁾
3	INTA# ¹⁾	INTB# ¹⁾	INTC# ¹⁾	5V	INTD# ¹⁾
2	<i>TCK</i> ⁴⁾	5V	<i>TMS</i> ⁴⁾	<i>TDO</i> ⁴⁾	<i>TDI</i> ⁴⁾
1	5V	-12V ⁵⁾	<i>TRST#</i> ⁴⁾	+12V ⁸⁾	5V

signals marked grey/italic are not connected

- 1) Various PCI control signals pulled up with 1k Ω to V(I/O). This value is specified for +5V V(I/O) but works as well with +3.3V V(I/O) under all environments which have been tested by EKF. On request, 2.7k Ω P/U resistors can be stuffed.
- 2) REQ64# and ACK64# not used on PC6-TANGO, though pulled up with 1k Ω to V(I/O).
- 3) IPMB SCL and SDA connected to APL-I SoC I2C port 1 via level shifter, pulled up with 2.7k to J1 pin A4 IPMB_PWR (+5V). IPMB_PWR can be sourced externally, and is also supplied by the PC6-TANGO across a Schottky diode.
- 4) All JTAG pins are NC since discouraged by CPCI specification Rev. 3.0
- 5) -12V connected to a decoupling capacitor only and not used on PC6-TANGO
- 6) BD_SEL# connected to PLD input, however not in logical use by default
- 7) M66EN is detected by the PCI bridge in order to allow either 66MHz PCI backplane operation, or when pulled low (by peripheral board) forces 33MHz clock. Please note that the PCI bridge can be setup also for 50MHz and 25MHz on customer request (resistor stuffing option). When operating in 66MHz (50MHz) a V(I/O) voltage of +3.3V is mandatory.
- 8) +12V passed through to mezzanine connectors P-HSE and P-EXP, not required for PC6-TANGO basic operation
- 9) The 3.3V pins can be sourced by the PC6-TANGO itself (power output via resettable fuse 2.0A), for +5V only power supply designs (consider power 3.3V power requirements of peripheral boards).

CompactPCI J2 (PlusIO)

This connector is a high speed UHM connector, suitable for Gigabit Serial I/O. Refer also to PICMG® 2.30 CompactPCI® PlusIO Specification.



J2 UHM (Top)
J1 (Bottom)

Please note, that the CompactPCI® PlusIO specification refers to SATA data rates of 1.5Gbps and 3Gbps. EKF has tested successfully also 6G over the backplane with sample devices, but cannot guarantee this data rate under any condition. Other devices and other backplane brands/types in use may cause a different result. Hence, for optimum reliability, the Marvell SATA controller will be initialized for 3Gbps by default. The J2 backplane SATA 6Gbps configuration would be available however as a PC6-TANGO option on special request (altered content for the Marvell 88SE9170 attached SPI Flash). EKF recommends that customers validate their particular SATA 6G application thoroughly, since SATA channel data errors can decrease the performance considerably.

Warning: Do not operate the standard PC6-TANGO in systems with a 64-bit CompactPCI® backplane. The J2/P2 pin assignment of a 64-bit CPCI backplane differs substantially from a CompactPCI® PlusIO backplane, which will result in an overvoltage or short circuit situation on several pins, causing permanent damage to the PC6-TANGO. For use together with a 64-bit CompactPCI® classic backplane, special PC6-TANGO versions are available on customer request, however supporting only 32-bit peripheral cards. The use of 64-bit CompactPCI® classic peripheral boards may cause problems.

J2	A	B	C	D	E
22	GA4 ²⁾	GA3 ²⁾	GA2 ²⁾	GA1 ²⁾	GA0 ²⁾
21	CLK6	GND	2_ETH_B+	1_ETH_D+	1_ETH_B+
20	CLK5	GND	2_ETH_B-	1_ETH_D-	1_ETH_B-
19	GND	GND	2_ETH_A+	1_ETH_C+	1_ETH_A+
18	2_ETH_D+	2_ETH_C+	2_ETH_A-	1_ETH_C-	1_ETH_A-
17	2_ETH_D-	2_ETH_C-	PRST# RST# ⁸⁾	REQ6# ¹⁾	GNT6#
16	4_PE_CLK-	2_PE_CLK+	DEG# ^{1) 4)}	GND	<i>reserved</i> ²⁾
15	4_PE_CLK+	2_PE_CLK-	FAL# ¹⁾ (PSON#) ⁶⁾	REQ5# ¹⁾	GNT5#
14	3_PE_CLK-	1_PE_CLK+	4_PE_CLKE#	PPS ⁵⁾ SATA_SCL ₄₎	<i>reserved</i> ²⁾
13	3_PE_CLK+	1_PE_CLK-	3_PE_CLKE#	PPM ⁵⁾ SATA_SDO ⁴⁾	SATA_SL ⁴⁾
12	4_PE_RX00+	1_PE_CLKE#	2_PE_CLKE#	SATA_SDI ⁴⁾	4_SATA_RX+ ⁷⁾
11	4_PE_RX00-	4_PE_TX00+	4_USB2+	4_SATA_TX+ ⁷⁾	4_SATA_RX- ⁷⁾
10	3_PE_RX00+	4_PE_TX00-	4_USB2-	4_SATA_TX- ⁷⁾	3_SATA_RX+
9	3_PE_RX00-	3_PE_TX00+	3_USB2+	3_SATA_TX+	3_SATA_RX-
8	2_PE_RX00+	3_PE_TX00-	3_USB2-	3_SATA_TX-	2_SATA_RX+
7	2_PE_RX00-	2_PE_TX00+	2_USB2+	2_SATA_TX+	2_SATA_RX-
6	1_PE_RX00+	2_PE_TX00-	2_USB2-	2_SATA_TX-	1_SATA_RX+
5	1_PE_RX00-	1_PE_TX00+	1_USB2+	1_SATA_TX+	1_SATA_RX-
4	V(I/O)	1_PE_TX00-	1_USB2-	1_SATA_TX-	<i>reserved</i> ²⁾
3	CLK4	GND	GNT3#	REQ4# ¹⁾	GNT4#
2	CLK2	CLK3	SYSEN# ³⁾	GNT2#	REQ3# ¹⁾
1	CLK1	GND	REQ1# ¹⁾	GNT1#	REQ2# ¹⁾

signals marked grey/italic are not connected

- 1) Various PCI control signals pulled up with 1kΩ to V(I/O). This resistor value is specified for +5V V(I/O) but works as well with +3.3V V(I/O) under all environments which have been tested by EKF. On request, 2.7kΩ P/U resistors can be stuffed.
- 2) GA pins and some other signals are not connected
- 3) SYSEN# is pulled up with 10kΩ to +3.3V
- 4) Signals terminated by P/U resistors, but not in use
- 5) PPS (pulse per second) and PPM (pulse per minute) as defined by IEEE 1588. These signals are derived from NIC1 (I210IT), and must be enabled by GPIO27 of the APL-I SoC, since this feature is EKF proprietary. According to the CompactPCI® Serial specification the SGPIO pins (i.e. PPM/PPS when enabled) are distributed via the CompactPCI® Serial backplane, and therefore can be used on a suitable peripheral card for triggering events. If a CompactPCI® Serial peripheral card makes use of the SGPIO sideband signals, the PPS/PPM signals should be disabled on the PC6-TANGO.
- 6) As an exclusive stuffing option J2-C15 can be utilised as PSON# output
- 7) The J2 backplane SATA port is available as an option, together with the on-board Marvell 88SE9170 SATA controller. Since the CompactPCI® PlusIO specification refers to SATA 3Gbps, the Marvell SATA controller will be initialized for 3G operation. On request, the PC6-TANGO is available with 6Gbps data rate for J2 SATA, but should be validated by the customer for the targeted environment.
- 8) PRST# is pulled up with 1kΩ to +3.3V. This is normally an input, for optional connection to a push button (manual reset actuator). As an option, this pin may be reconfigured as RST# output (platform reset). This will be required for applications which address PCI Express® peripheral devices only via the rear I/O backplane connector J2, e.g. RIO modules. A similar situation arises as result of an optional PC6-TANGO stand-alone configuration, where the backplane connector J1 has been replaced by a +5V terminal block. While J1 is present, RST# would be available on pin J1 C5. Without J1 however, the RST# output must be derived from J2 C17 as an alternate. Hence, if J1 is not populated on the PC6-TANGO, backplane slots which are based on PCI Express® (typically configured according to CompactPCI® Serial) must be connected to J2/P2 C17 as platform reset.

Mechanical Drawing

The following drawing shows the positions of mounting holes and expansion connectors on the PC6-TANGO.

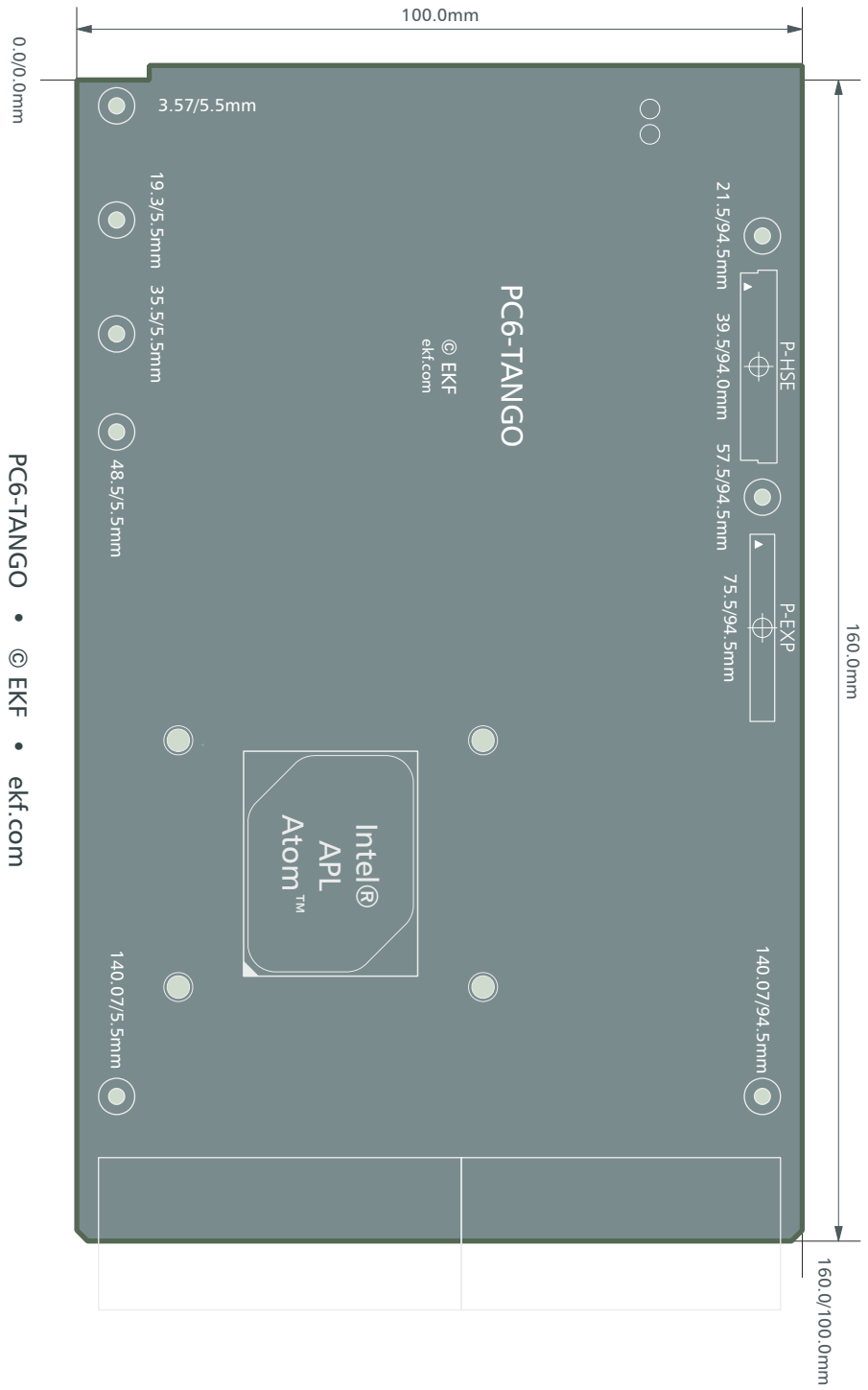

PC6-TANGO • © EKF • ekf.com

Industrial Computers Made in Germany
boards. systems. solutions.

Beyond All Limits:
EKF High Performance Embedded

EKF Elektronik GmbH
Philipp-Reis-Str. 4 (Haus 1)
Lilienthalstr. 2 (Haus 2)
59065 HAMM
Germany



Phone +49 (0)2381/6890-0
Fax +49 (0)2381/6890-90
Internet www.ekf.com
E-Mail sales@ekf.com